

PRODUCTS CATALOGUE

"AT EASE IN YOUR CONSTRUCTION SITE"

www.ritmo.it





Ritmo meets all your welding needs in your jobsite



The information and photos in this publication are not binding and RITMO S.P.A. is free to make any alterations without prior notice.

INDEX

BUTT FUSION MACHINES - HIGH PRESSURE

| | | |
|---------------------------------------|------|----|
| BUTT FUSION LINE | pag. | 11 |
| REFERENCE mm - IPS - DIPS | pag. | 12 |
| MANUAL BUTT FUSION MACHINES | pag. | 14 |
| COMPACT 355 L pre-insulated pipe | pag. | 18 |
| EASY LIFE SYSTEM | pag. | 19 |
| APP SET & GO PRO | pag. | 20 |
| EASY LIFE LINE | pag. | 22 |
| BASIC LINE | pag. | 36 |
| DELTA LINE | pag. | 46 |
| AUTOMATIC BUTT FUSION MACHINES | pag. | 60 |
| ALL TERRAIN - TRAILER LINE | pag. | 62 |
| DATA-LOGGING | pag. | 79 |
| ACCESSORIES for butt fusion | pag. | 80 |

ELECTROFUSION MACHINES

| | | |
|---|------|----|
| ELECTROFUSION LINE - HIGH PRESSURE | pag. | 84 |
| ELEKTRA LINE - overview | pag. | 92 |
| ELECTROFUSION LINE - LIQUID DRAINAGE | pag. | 93 |
| ACCESSORIES and TOOLS for Electrofusion | pag. | 94 |

SOCKET FUSION

| | | |
|---------------------------------|------|-----|
| MANUAL SOCKET WELDERS | pag. | 105 |
| SOCKET WELDING MACHINES | pag. | 106 |
| SPECIAL SOCKET WELDING MACHINES | pag. | 112 |
| SOCKET & SPIGOTS | pag. | 114 |

FITTINGS FABRICATION MACHINES and BAND SAWS

| | | |
|-------------|------|-----|
| ALFA LINE | pag. | 116 |
| OMEGA LINE | pag. | 128 |
| SPECIAL SAW | pag. | 130 |
| SIGMA LINE | pag. | 132 |

PLASTIC FABRICATIONS

| | | |
|----------------------------|------|-----|
| STARGUN LINE | pag. | 136 |
| FLOW LINE | pag. | 146 |
| POLYFUSION LINE | pag. | 148 |
| POLYFUSION LINE - overview | pag. | 162 |

BUTT FUSION MACHINES - LIQUID DRAINAGE

| | | |
|-------------------------|------|-----|
| HEATING PLATES | pag. | 165 |
| MANUAL BUTT FUSION LINE | pag. | 166 |



Since 1979 RITMO S.P.A. is a world leader in manufacturing of plastic welding equipment. All products are designed and built according to International standards and directives (UNI, ISO, CEE). Since the very beginning, quality and technology innovation are RITMO's milestones, and time after time, this philosophy is always more recognized by the global market. RITMO strong points are its ideas to design and produce accurate, fast, versatile, modular and easy-to-use welding machines. Products range includes butt fusion, electrofusion and extrusion equipment. Ritmo is also providing a complete line of accessories and useful instruments for pipe cutting and weld preparation such as the band saws. RITMO's regards towards the client has brought to the new-born "RITMO FUSION OPERATOR SCHOOL", which is a welding school with the goal of building qualified personnel and spread the knowledge about the technical potentiality of RITMO's equipment: TECHNOLOGY MADE IN ITALY.

MADE IN ITALY

DESIGNED & MANUFACTURED
IN ITALY



watch the video

www.ritmo.it

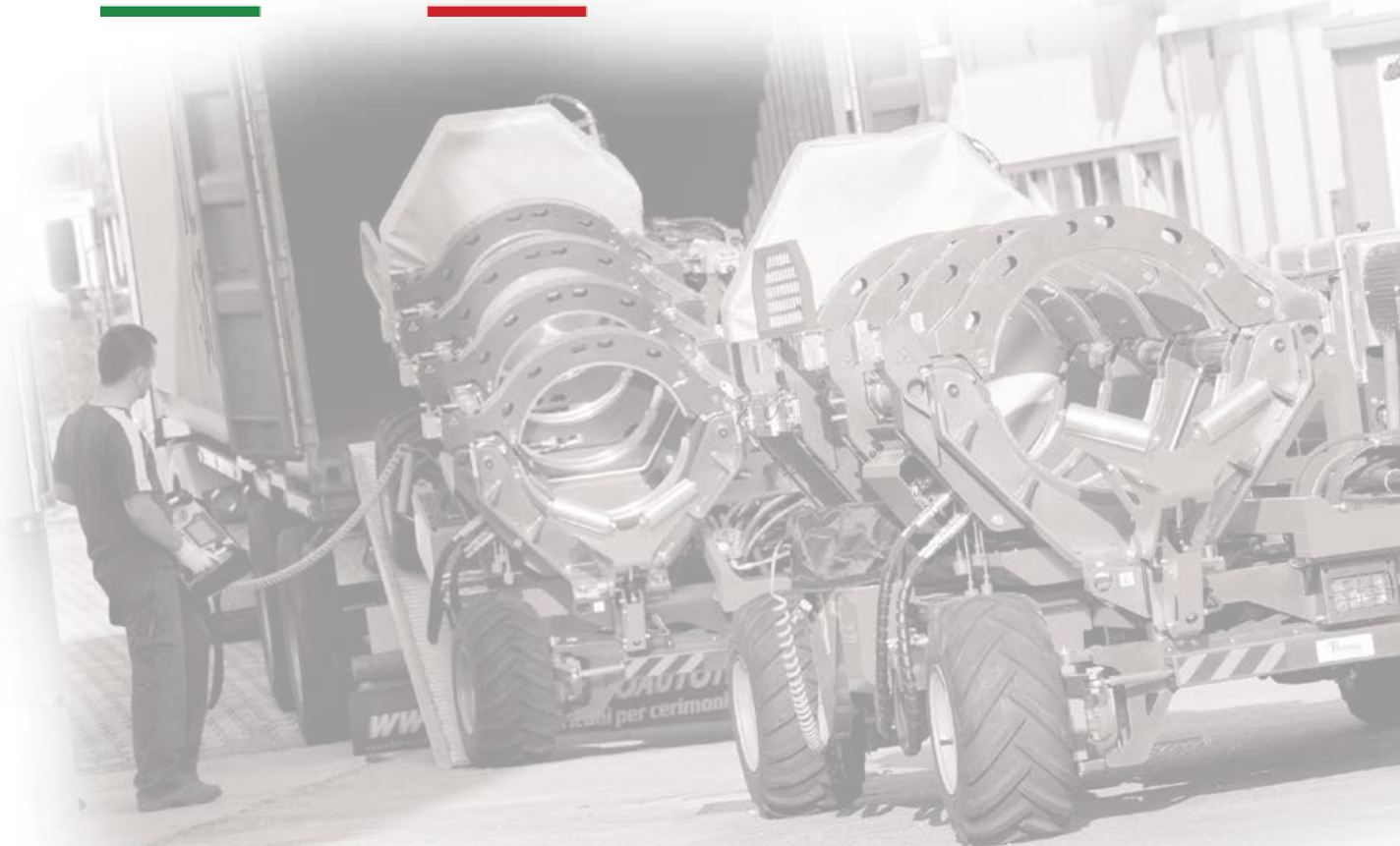



Rossella Contiero - Managing Director

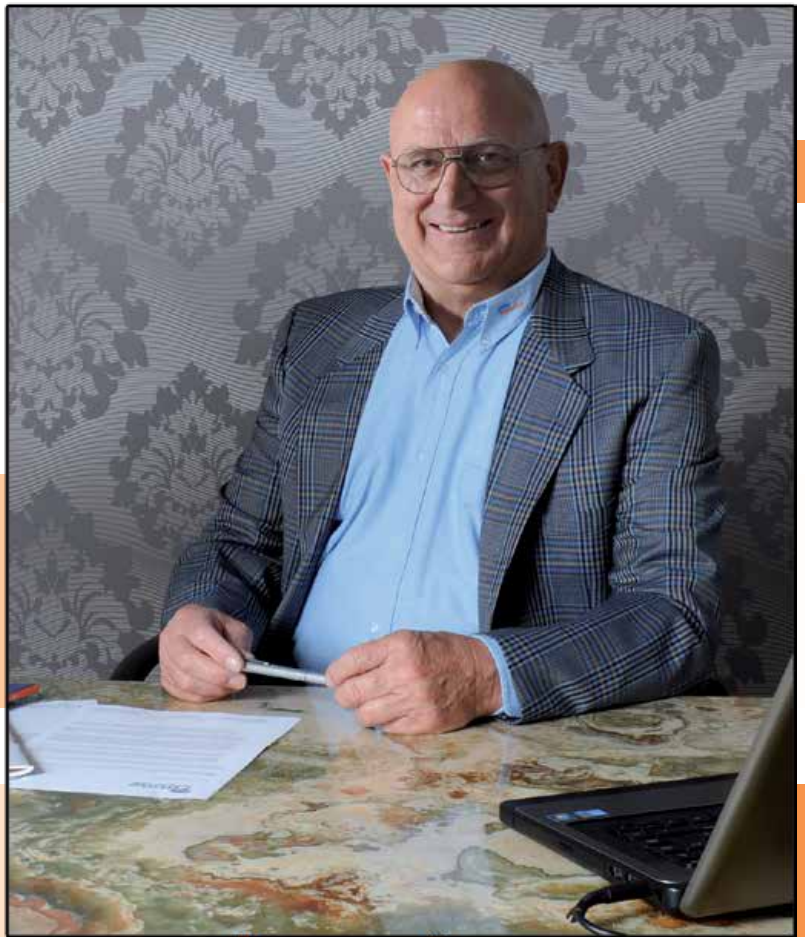

Renzo Bortoli - President



ISO 9001
Quality System



Follow RITMO on



www.youtube.com/user/RitmoPlasticWelding



1979 year of RITMO's foundation
1979 launched Delta line
1983 launched Alfa line
1986 moved into the new headquarters
1995 reached 50 employees
2002 first Easy Life welding machine
2003 reached 100 employees
2006 launched All Terrain line
2008 launched Elektra line
2009 launched Basic line
2010 launched Omega line
2012 launched Polyfusion line
2015 launched APP "Set & Go"
2017 launched K-SB extruder welders
2018 launched Prisma UP 90



- **OVER 100 PRODUCTS ON CATALOG**
- **90% EXPORT**
- **130 countries where RITMO has been supplying products**



ADVANTAGE

RITMO



RITMO WORLDWIDE

Ritmo has professional distributors and resellers all over the world. Our staff is ready to assist you in English, Spanish, French, German, Arab, Italian, Russian and Portuguese.

TRAINING

From many years now, we have decided that the best way to grant a client/distributor a perfect knowledge of our products is to invest in custom training, in our own premises. These courses are aimed to teach how to operate the products in the best way, and how to supply the “first aid” when necessary.

PRESALES TECHNICAL ASSISTANCE

When a client or a potential client wants to buy us a product, it is our standard procedure to help find the best solution to its needs.

GLOBAL ADVICE

In such a technical field as ours, the customer requires the best assistance. Thanks to the experience developed along the years, and to the co-operation with several manufacturers, institutions, schools and training institutes, RITMO is able to give the most comprehensive advice to no matter which related issue. Our company is a long-time member of a UNIPLAST's (UNI-Italian National Plastics Standards Body) working group dedicated to the study and draw up of new standards within our field. The importance of this group is linked to the fact that the expansion of the plastic welding field ought to be followed by a crescent sensitivity for safety issues, so to have a sustainable and continuous growth. The working group prepares draws, hence present them to the UNI to be discussed and eventually transformed into new standards.

AFTER SALES TECHNICAL ASSISTANCE

Ritmo's Service Centre can solve all kind of technical issues, as well as overhaul our machines. Ritmo has other Service Centres abroad, linked to its official distributors.

STARTING AND TESTING

RITMO' technicians are prepared to make the starting and testing of workshop machines at the client' own premises, so that the fittings production can start almost immediately.



IMPROVE YOUR KNOWLEDGE ON RITMO'S EQUIPMENT

The aim of the course is to prepare specialized operators on the use of Ritmo Products.

Some of the subjects discussed such as the correct preparation of pipes, welding parameters and welding techniques, allow to learn essential information; not only for those who are new in the field but also for experts. The course includes theory and practice.

At the end of the course, participants will receive a Training Certificate.



for more details: info@ritmo.it





Ritmo
PLASTIC WELDING TECHNOLOGY



RITMO'S BUTT FUSION MACHINES: WORK PHILOSOPHY AVAILABLE TO EVERYONE!

- **MANUAL**

welding machines without hydraulic gearcase



- **HYDRAULIC**

welding machines with hydraulic gearcase



- **EASY LIFE SYSTEM** *HIGH LEVEL PERFORMANCE*

automated welding cycle

welding machines with special hydraulic gearcase

Hardware and Software interact to the entire workflow

repetition of welding cycles

GPS, data-logging and report PDF,

APP "SET & GO PRO" (optional)

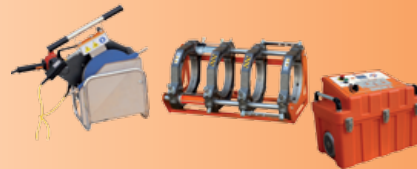

- **ALL TERRAIN** *HIGH LEVEL PERFORMANCE*

self-contained generator on board

self-propelled

trolley with wheels

welding machines with special hydraulic gearcase

automated welding cycle

Hardware and Software interact to the entire workflow

repetition of welding cycles

GPS, data-logging and report PDF,

APP "SET & GO PRO" (optional)



- **CNC** *HIGH LEVEL PERFORMANCE*

automatic welding cycle

special hydraulic gearcase and machine body with

integrated mechanical extraction of heating plate

Hardware and Software interact to the entire workflow

repetition of welding cycles

GPS, data-logging and report PDF



BUTT FUSION MACHINES REFERENCE



| WORKING RANGE Ø mm | 32 | 40 | 50 | 63 | 75 | 90 | 110 | 125 | 140 | 160 | 180 | 200 | 225 | 250 | 280 | 315 | 355 | 400 | 450 | 500 | 560 | 630 | 710 | 800 | 900 | 1000 | 1200 | 1400 | 1600 | |
|---------------------------|----|----|----|----|----|----|-----|-----|-----|-----|-----|-----|-----|-----|-----|-----|-----|-----|-----|-----|-----|-----|-----|-----|-----|------|------|------|------|------|
| GAMMA 160 | | 40 | 50 | 63 | 75 | 90 | 110 | 125 | 140 | 160 | | | | | | | | | | | | | | | | | | | | |
| DELTA 160 M | 32 | 40 | 50 | 63 | 75 | 90 | 110 | 125 | 140 | 160 | | | | | | | | | | | | | | | | | | | | |
| DELTA 200 M | | | | 63 | 75 | 90 | 110 | 125 | 140 | 160 | 180 | 200 | | | | | | | | | | | | | | | | | | |
| BASIC 160 | | 40 | 50 | 63 | 75 | 90 | 110 | 125 | 140 | 160 | | | | | | | | | | | | | | | | | | | | |
| BASIC 200 | | | | 63 | 75 | 90 | 110 | 125 | 140 | 160 | 180 | 200 | | | | | | | | | | | | | | | | | | |
| BASIC 250 | | | | | 75 | 90 | 110 | 125 | 140 | 160 | 180 | 200 | 225 | 250 | | | | | | | | | | | | | | | | |
| BASIC 315 | | | | | | 90 | 110 | 125 | 140 | 160 | 180 | 200 | 225 | 250 | 280 | 315 | | | | | | | | | | | | | | |
| BASIC 355 | | | | | | | | 125 | 140 | 160 | 180 | 200 | 225 | 250 | 280 | 315 | 355 | | | | | | | | | | | | | |
| COMPACT 355 | | | | | | | | 125 | 140 | 160 | 180 | 200 | 225 | 250 | 280 | 315 | 355 | | | | | | | | | | | | | |
| BASIC 160 EASY LIFE | | 40 | 50 | 63 | 75 | 90 | 110 | 125 | 140 | 160 | | | | | | | | | | | | | | | | | | | | |
| BASIC 200 EASY LIFE | | | | 63 | 75 | 90 | 110 | 125 | 140 | 160 | 180 | 200 | | | | | | | | | | | | | | | | | | |
| BASIC 250 EASY LIFE | | | | | 75 | 90 | 110 | 125 | 140 | 160 | 180 | 200 | 225 | 250 | | | | | | | | | | | | | | | | |
| BASIC 315 EASY LIFE | | | | | | 90 | 110 | 125 | 140 | 160 | 180 | 200 | 225 | 250 | 280 | 315 | | | | | | | | | | | | | | |
| BASIC 355 EASY LIFE | | | | | | | | 125 | 140 | 160 | 180 | 200 | 225 | 250 | 280 | 315 | 355 | | | | | | | | | | | | | |
| DELTA 500 EASY LIFE | | | | | | | | | | | | 200 | 225 | 250 | 280 | 315 | 355 | 400 | 450 | 500 | | | | | | | | | | |
| DELTA 630 EASY LIFE | | | | | | | | | | | | | | | 280 | 315 | 355 | 400 | 450 | 500 | 560 | 630 | | | | | | | | |
| DELTA 500 | | | | | | | | | | | | 200 | 225 | 250 | 280 | 315 | 355 | 400 | 450 | 500 | | | | | | | | | | |
| DELTA 630 | | | | | | | | | | | | | | | 280 | 315 | 355 | 400 | 450 | 500 | 560 | 630 | | | | | | | | |
| DELTA 800 | | | | | | | | | | | | | | | | | | | | | 500 | 560 | 630 | 710 | 800 | | | | | |
| DELTA 1000 | | | | | | | | | | | | | | | | | | | | | | | 630 | 710 | 800 | 900 | 1000 | | | |
| DELTA 1200 | | | | | | | | | | | | | | | | | | | | | | | | 710 | 800 | 900 | 1000 | 1200 | | |
| DELTA 1600 ECO / 1600 HDR | | | | | | | | | | | | | | | | | | | | | | | | | 800 | 900 | 1000 | 1200 | 1400 | 1600 |
| DELTA 250 TRAILER | | | | | 75 | 90 | 110 | 125 | 140 | 160 | 180 | 200 | 225 | 250 | | | | | | | | | | | | | | | | |
| DELTA 355 TRAILER | | | | | | | | 125 | 140 | 160 | 180 | 200 | 225 | 250 | 280 | 315 | 355 | | | | | | | | | | | | | |
| DELTA 355 ALL TERRAIN | | | | | | | | 125 | 140 | 160 | 180 | 200 | 225 | 250 | 280 | 315 | 355 | | | | | | | | | | | | | |
| DELTA 500 TRAILER | | | | | | | | | | | | 200 | 225 | 250 | 280 | 315 | 355 | 400 | 450 | 500 | | | | | | | | | | |
| DELTA 500 ALL TERRAIN | | | | | | | | | | | | 200 | 225 | 250 | 280 | 315 | 355 | 400 | 450 | 500 | | | | | | | | | | |
| DELTA 630 TRAILER | | | | | | | | | | | | | 225 | 250 | 280 | 315 | 355 | 400 | 450 | 500 | 560 | 630 | | | | | | | | |
| DELTA 630 ALL TERRAIN | | | | | | | | | | | | | 225 | 250 | 280 | 315 | 355 | 400 | 450 | 500 | 560 | 630 | | | | | | | | |
| DELTA 1000 TRAILER | | | | | | | | | | | | | | | | 315 | 355 | 400 | 450 | 500 | 560 | 630 | 710 | 800 | 900 | 1000 | | | | |
| DELTA DRAGON 250 CNC | | | | | 75 | 90 | 110 | 125 | 140 | 160 | 180 | 200 | 225 | 250 | | | | | | | | | | | | | | | | |
| DELTA DRAGON 315 CNC | | | | | | 90 | 110 | 125 | 140 | 160 | 180 | 200 | 225 | 250 | 280 | 315 | | | | | | | | | | | | | | |
| WORKING RANGE Ø mm | 32 | 40 | 50 | 63 | 75 | 90 | 110 | 125 | 140 | 160 | 180 | 200 | 225 | 250 | 280 | 315 | 355 | 400 | 450 | 500 | 560 | 630 | 710 | 800 | 900 | 1000 | 1200 | 1400 | 1600 | |

| CTS | IPS | | | | | | | | | | | | | | | | | | | | | | | | | | | | | | | | | | | | | |
|---------------------------|-----|-----|-----|----|----|-----|-----|----|----|----|----|----|----|-----|-----|-----|-----|-----|-----|-----|-----|-----|-----|-----|-----|-----|-----|-----|-----|-----|-----|-----|--|--|--|--|--|--|
| | 1" | 1½" | 1½" | 2" | 1" | 1¼" | 1½" | 2" | 3" | 4" | 5" | 6" | 8" | 10" | 12" | 14" | 16" | 18" | 20" | 22" | 24" | 26" | 28" | 30" | 32" | 34" | 36" | 42" | 48" | 52" | 54" | 63" | | | | | | |
| GAMMA 160 | | | | | | | | | | | | | | | | | | | | | | | | | | | | | | | | | | | | | | |
| DELTA 160 M | • | • | • | • | • | • | • | • | • | • | • | • | | | | | | | | | | | | | | | | | | | | | | | | | | |
| DELTA 200 M | | | | | | | | | | | | | | | | | | | | | | | | | | | | | | | | | | | | | | |
| BASIC 160 | | | | | | | | | | | | | | | | | | | | | | | | | | | | | | | | | | | | | | |
| BASIC 200 | | | | | | | | | | | | | | | | | | | | | | | | | | | | | | | | | | | | | | |
| BASIC 250 | | | | | | | | | | | | | | | | | | | | | | | | | | | | | | | | | | | | | | |
| BASIC 315 | | | | | | | | | | | | | | | | | | | | | | | | | | | | | | | | | | | | | | |
| BASIC 355 | | | | | | | | | | | | | | | | | | | | | | | | | | | | | | | | | | | | | | |
| COMPACT 355 | | | | | | | | | | | | | | | | | | | | | | | | | | | | | | | | | | | | | | |
| BASIC 160 EASY LIFE | | | | | | | | | | | | | | | | | | | | | | | | | | | | | | | | | | | | | | |
| BASIC 200 EASY LIFE | | | | | | | | | | | | | | | | | | | | | | | | | | | | | | | | | | | | | | |
| BASIC 250 EASY LIFE | | | | | | | | | | | | | | | | | | | | | | | | | | | | | | | | | | | | | | |
| BASIC 315 EASY LIFE | | | | | | | | | | | | | | | | | | | | | | | | | | | | | | | | | | | | | | |
| BASIC 355 EASY LIFE | | | | | | | | | | | | | | | | | | | | | | | | | | | | | | | | | | | | | | |
| DELTA 500 EASY LIFE | | | | | | | | | | | | | | | | | | | | | | | | | | | | | | | | | | | | | | |
| DELTA 630 EASY LIFE | | | | | | | | | | | | | | | | | | | | | | | | | | | | | | | | | | | | | | |
| DELTA 500 | | | | | | | | | | | | | | | | | | | | | | | | | | | | | | | | | | | | | | |
| DELTA 630 | | | | | | | | | | | | | | | | | | | | | | | | | | | | | | | | | | | | | | |
| DELTA 800 | | | | | | | | | | | | | | | | | | | | | | | | | | | | | | | | | | | | | | |
| DELTA 1000 | | | | | | | | | | | | | | | | | | | | | | | | | | | | | | | | | | | | | | |
| DELTA 48" | | | | | | | | | | | | | | | | | | | | | | | | | | | | | | | | | | | | | | |
| DELTA 1600 ECO / 1600 HDR | | | | | | | | | | | | | | | | | | | | | | | | | | | | | | | | | | | | | | |
| DELTA TRAILER 250 | | | | | | | | | | | | | | | | | | | | | | | | | | | | | | | | | | | | | | |
| DELTA 355 TRAILER | | | | | | | | | | | | | | | | | | | | | | | | | | | | | | | | | | | | | | |
| DELTA 355 ALL TERRAIN | | | | | | | | | | | | | | | | | | | | | | | | | | | | | | | | | | | | | | |
| DELTA 500 TRAILER | | | | | | | | | | | | | | | | | | | | | | | | | | | | | | | | | | | | | | |
| DELTA 500 ALL TERRAIN | | | | | | | | | | | | | | | | | | | | | | | | | | | | | | | | | | | | | | |
| DELTA 630 TRAILER | | | | | | | | | | | | | | | | | | | | | | | | | | | | | | | | | | | | | | |
| DELTA 630 ALL TERRAIN | | | | | | | | | | | | | | | | | | | | | | | | | | | | | | | | | | | | | | |
| DELTA 1000 TRAILER | | | | | | | | | | | | | | | | | | | | | | | | | | | | | | | | | | | | | | |
| IPS | 1" | 1½" | 1½" | 2" | 1" | 1¼" | 1½" | 2" | 3" | 4" | 5" | 6" | 8" | 10" | 12" | 14" | 16" | 18" | 20" | 22" | 24" | 26" | 28" | 30" | 32" | 34" | 36" | 42" | 48" | 52" | 54" | 63" | | | | | | |

| DIPS | | | | | | | | | | | | | | | | | |
|---------------------------|----|----|----|----|-----|-----|-----|-----|-----|-----|-----|-----|-----|-----|-----|-----|-----|
| | 3" | 4" | 6" | 8" | 10" | 12" | 14" | 16" | 18" | 20" | 24" | 30" | 36" | 42" | 48" | 54" | 60" |
| GAMMA 160 | | | | | | | | | | | | | | | | | |
| DELTA 160 M | • | • | | | | | | | | | | | | | | | |
| DELTA 200 M | • | • | • | | | | | | | | | | | | | | |
| BASIC 160 | • | • | | | | | | | | | | | | | | | |
| BASIC 200 | • | • | • | | | | | | | | | | | | | | |
| BASIC 250 | • | • | • | • | | | | | | | | | | | | | |
| BASIC 315 | • | • | • | • | • | | | | | | | | | | | | |
| BASIC 355 | • | • | • | • | • | • | | | | | | | | | | | |
| COMPACT 355 | • | • | • | • | • | • | | | | | | | | | | | |
| BASIC 160 EASY LIFE | • | • | | | | | | | | | | | | | | | |
| BASIC 200 EASY LIFE | • | • | • | | | | | | | | | | | | | | |
| BASIC 250 EASY LIFE | • | • | • | • | | | | | | | | | | | | | |
| BASIC 315 EASY LIFE | • | • | • | • | • | | | | | | | | | | | | |
| BASIC 355 EASY LIFE | • | • | • | • | • | • | | | | | | | | | | | |
| DELTA 500 EASY LIFE | | | | | | | | | | | | | | | | | |
| DELTA 630 EASY LIFE | | | | | | | | | | | | | | | | | |
| DELTA 500 | | | | | | | | | | | | | | | | | |
| DELTA 630 | | | | | | | | | | | | | | | | | |
| DELTA 800 | | | | | | | | | | | | | | | | | |
| DELTA 48" | | | | | | | | | | | | | | | | | |
| DELTA 1600 ECO / 1600 HDR | | | | | | | | | | | | | | | | | |
| DELTA TRAILER 250 | • | • | • | • | | | | | | | | | | | | | |
| DELTA 355 TRAILER | • | • | • | • | • | | | | | | | | | | | | |
| DELTA 355 ALL TERRAIN | • | • | • | • | • | • | | | | | | | | | | | |
| DELTA 500 TRAILER | • | • | • | • | • | • | | | | | | | | | | | |
| DELTA 500 ALL TERRAIN | • | • | • | • | • | • | • | | | | | | | | | | |
| DELTA 630 TRAILER | • | • | • | • | • | • | • | | | | | | | | | | |
| DELTA 630 ALL TERRAIN | • | • | • | • | • | • | • | • | | | | | | | | | |
| DELTA 1000 TRAILER | • | • | • | • | • | • | • | • | | | | | | | | | |
| DIPS | 3" | 4" | 6" | 8" | 10" | 12" | 14" | 16" | 18" | 20" | 24" | 30" | 36" | 42" | 48" | 54" | 60" |





GAMMA 160

GAMMA 160 is a manual butt welding machine for HDPE and PP pipes up to \varnothing 160 mm (4" DIPS). GAMMA 160 features special jaws for **manufacturing elbows**. Machine can also weld moulded fittings like bends, tees, wyes (Y) and flange necks up to \varnothing 160 mm; short flange necks can be welded with the help of a stub end holder (on request), applied to the clamps. Machine body of GAMMA 160 is compact and easy to transport. Available in the 110 V or 230 V version.

STANDARD COMPOSITION

- A machine body with pressure regulating device of the bench vice closure
- A steel frame for the support of the machine body
- Steel sliding clamps with fast closing system
- An heating plate with an electronic temperature control device
- An electrically controlled milling cutter for levelling the ends of the pipe and/or fitting, with safety micro-switch against accidental starters
- A support for the milling cutter and the heating plate
- Steel adapters \varnothing 40, 50, 63, 75, 90, 110, 125, 140 mm (1½" IPS ÷ 4" DIPS)
- A case for the adapters

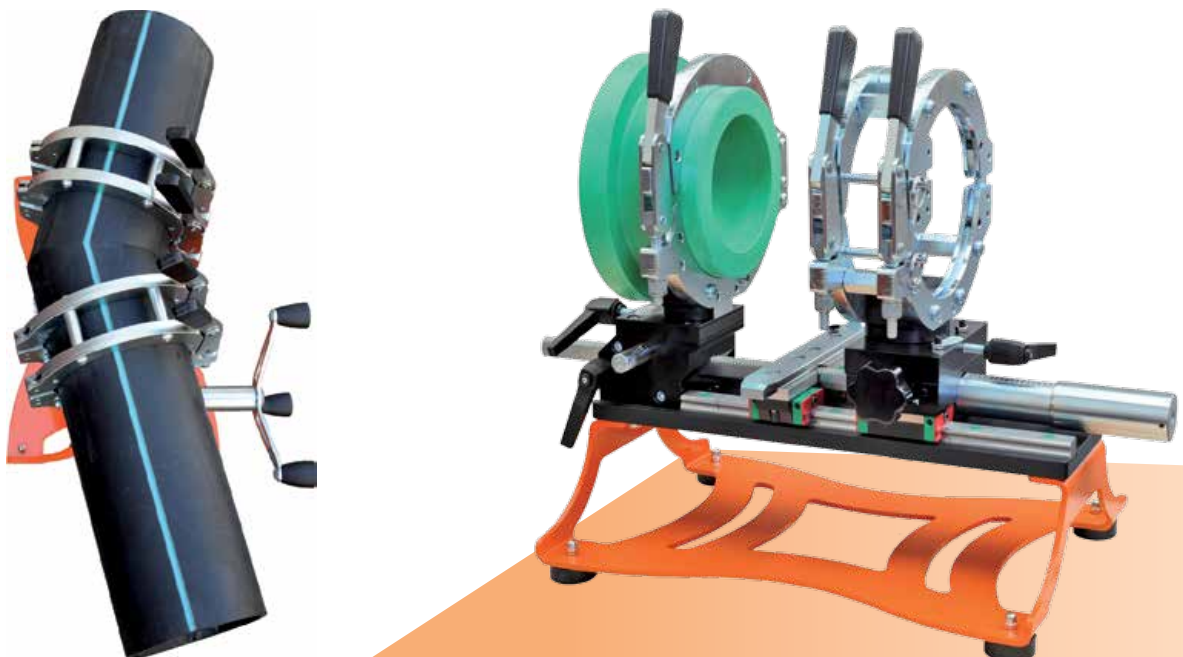

TECHNICAL FEATURES

PLUS

**MANUFACTURING
ELBOWS**

**SPECIAL CLAMP
FOR FITTINGS**

| | |
|-----------------------------|--|
| Working range | 40 ÷ 160 mm; 1½" IPS ÷ 4" DIPS |
| Materials | HDPE, PP, PVDF For other materials contact RITMO S.P.A. |
| Power supply | 110 V Single Phase 50/60 Hz 230 V Single Phase 50/60 Hz |
| Total absorbed power | 2020 W (110 V) 1600 W (230 V) |
| Weight machine body | 25 Kg (55.1 lb) |
| Weight standard composition | 85 Kg (187,4 lb) |
| Dimensions machine body | 610 x 300 x 470 mm 24" x 11.8" x 18,5" |

ON REQUEST

Ø 1½" ÷ 4" DIPS;
tool for flange necks,
thin single clamp.



PLUS

32 ÷ 160 mm

**CLAMP-ALIGNER
SYSTEM PATENTED
BY RITMO**



DELTA 160 M

DELTA 160 M is a manual butt fusion welder for pipes up to \varnothing 160 mm up to 4" DIPS. Leading particulars are the restricted weight, minimum overall dimensions and versatility. Featuring: a machine body, two clamps, an extractable electric milling cutter provided with a safety micro-switch, an extractable heating plate (with an independent thermometer to see the real working temperature and an electronic thermoregulator "Digital Dragon" with display), and two lateral supports on request. DELTA 160 M have a locking device clamps - aligner RITMO Patented, that helps the operator to apply the necessary welding force. The Digital Dragon is an high precision electronic thermoregulator ($\pm 1^\circ$ C accuracy) with digital display and regulating buttons. This new system includes Led indicators to check if the machine is working normally (live tension and working temperature), contingent probe's failures and/or temperature anomalies.

STANDARD COMPOSITION

- Machine body
- Heating plate with digital electronic temperature control
- Milling cutter
- Milling cutter/Heating plate support with pre-insulate bag

ON REQUEST

Clamps' inserts from \varnothing 32 to 140 mm;
 \varnothing 1" ÷ 2" CTS; \varnothing 1" ÷ 4" IPS; \varnothing 3" ÷ 4" DIPS
 Lateral support (while stocks last)
 Trolley for machine transportation and support (while stocks last)



TECHNICAL FEATURES

| | |
|---------------------------|--|
| Working range | 32 ÷ 160 mm: 1" CTS ÷ 4" DIPS |
| Materials | HDPE, PP For other materials contact RITMO S.P.A. |
| Power supply* | 110 V Single Phase 50/60 Hz 230 V Single Phase 50/60 Hz |
| Total absorbed power | 2020 W (110 V) 1600 W (230 V) |
| Working temperature | 180° ÷ 280° C (356° ÷ 536° F) |
| Outside temperature range | -10° ÷ 40° C (14° ÷ 104° F) |
| Weight machine body | 35 Kg (77.1 lb) |
| Dimensions machine body | 450 x 384 x 830 mm 17.7" x 15.1" x 32.6" |

* Suggested power generator 3,5 ÷ 4kVA

PLUS

63 ÷ 200 mm

DIGITAL DRAGON

High-Precision
Electronic
Thermoregulator



DELTA 200 M

DELTA 200 M is a manual butt fusion welder for pipes up to \varnothing 200 mm (6" DISP). Leading particulars are the restricted weight, minimum overall dimensions and versatility. Featuring: a machine body, two clamps, an extractable electric milling cutter provided with a safety micro-switch, an extractable heating plate (with an independent thermometer to see the real working temperature and an electronic thermoregulator "Digital Dragon" with display), DELTA 200 M have a locking device clamps - aligner that helps the operator to apply the necessary welding force. The Digital Dragon is an high precision electronic thermoregulator ($\pm 1^\circ$ C accuracy) with digital display and regulating buttons. This new system includes Led indicators to check if the machine is working normally (live tension and working temperature), contingent probe's failures and/or temperature anomalies.

STANDARD COMPOSITION

- Machine body
- Heating plate with digital electronic temperature control
- Milling cutter
- Milling cutter/Heating plate support with pre-insulated bag for heating plate

ON REQUEST

Clamps' inserts from \varnothing 63 to 180 mm;
 \varnothing 2" ÷ 6" IPS; \varnothing 3" ÷ 6" DIPS
Trolley for machine transportation and support



TECHNICAL FEATURES

| | |
|---------------------------|--|
| Working range | 63 ÷ 200 mm: 2" IPS ÷ 6" DIPS |
| Materials | HDPE, PP For other materials contact RITMO S.P.A. |
| Power supply* | 110 V Single Phase 50/60 Hz 230 V Single Phase 50/60 Hz |
| Total absorbed power | 3000 W (110 V) 3000 W (230 V) |
| Working temperature | 180° ÷ 280° C (356° ÷ 536° F) |
| Outside temperature range | -10° ÷ 40° C; (14° ÷ 104° F) |
| Weight machine body | 30 Kg (66.1 lb) |
| Dimensions machine body | 529 x 499 x 1100 mm 20.8" x 19.6" x 43.3" |

* Suggested power generator 5,5 ÷ 6kVA



COMPACT 355

COMPACT 355 is a worksite machine for pre-insulated pipes in PE, HDPE, PP, from OD 125 to 355 mm.

Its small dimensions allow it to operate easily inside a dig, plus:

- the machine has a 2-clamp machine body, to lock the outer coating of the pre-insulated pipe
- its heating plate features the well known Digital Dragon high precision thermoregulator
- the electrohydraulic gearcase comes inside a protective box
- the milling cutter has a safety microswitch

STANDARD COMPOSITION

Machine body, electrohydraulic gearcase, milling cutter, heating plate with high precision thermoregulator, milling cutter/heating plate support, tool kit.

ON REQUEST

OD \varnothing 125 ÷ 315 mm inserts with a Master \varnothing 250 mm adapter, tool for flange necks.

TECHNICAL FEATURES

| | |
|-----------------------------|--|
| Working range | 125 ÷ 355 mm |
| Materials | HDPE, PP For other materials contact RITMO S.P.A. |
| Power supply | 230 V Single Phase 50/60 Hz |
| Total absorbed power | 5100 W |
| Weight machine body | 59 Kg (130 lb) |
| Weight standard composition | 144 Kg (317,5 lb) |
| Dimensions machine body | 458 x 790 x 580 mm 18" x 31.1" x 22,8" |





EASY LIFE CONCEPT



EASY LIKE PUSHING A BUTTON

This is the concept that developed the EASY LIFE welding system: *“to simplify the work in the jobsite avoiding human mistakes”*; this is the philosophy that it holds in its name *“Style and Technology”* by RITMO. EASY LIFE is a whole RITMO’s project for all and accessible to everybody. Easy Life is *“Wi-Fi” ready and works together with the App “SET & GO - PRO”*.

HOW DOES IT WORK

Hardware and software have been developed to interact to each other sharing data during the entire workflow. Once set the welding parameters up, the system guarantees the repetition of the welding cycle, avoiding errors. The operator only has to confirm the work phases on the gear case when asked to, just pushing a button. Besides, during the “welding phase”, where sometimes some pressure adjustments are needed, the electronics system solve automatically this specific problem.

QUALITY IN WELDING

The Easy Life system incorporates a data-logging that saves the data in an internal hard-drive capable to store up to 4000 welds. Possibility to pre-set 50 customized welding cycles. The data will be available through PDF reports, downloadable in a USB pen drive.

EXTREME RELIABILITY

Born on 2002, the EASY LIFE system is now at its fourth evolution.



“SET & GO PRO” APP

HIGH QUALITY ON BUTT FUSION WELDING



"SET & GO PRO" a Professional application for smartphones and tablets (Android) that changes forever the way to work with the Ritmo Easy Life butt fusion machines.

"SET & GO PRO" Put together the ease of use, innovation and quality, in a system with the advantages of a CNC welding system, but reducing significantly the costs of it.

ADVANTAGES

It eliminates the expensive hardware of a data-logging and offer the highest quality at the lowest cost.



From APP STORE you can use only SET & GO
SET & GO PRO isn't available.



PLUS

**EASY SETTING
WI-FI READY**

**GEOLOCATION
MAP**

**DATA-LOGGING
REPORT PDF**



watch the video

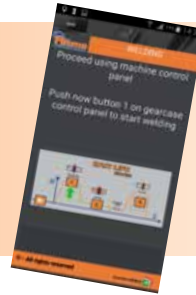

HOW DOES IT WORK?

Set-up the easy life welding machine through your smart-phone/tablet with few and easy steps: choose the international welding standards (ISO, DVS, UNI, ASTM, etc.), pipe diameter and SDR.

With the GPS and smartphone scanner you can collect, transfer, and store information by project name. You can record the exact location of each pipe weld as well as the construction site, you can scan pipe and fitting barcodes, scan operator badge, and take a photo before and after the installation.

With a detailed report at the end of each weld you have all the technical data with exact graphs and parameters to compare against international welding standards and geolocation map. You can quickly share the welding reports in pdf format via email and whatsapp or save them to your phone or on a cloud archive.

Choose "SET & GO PRO" because safety and quality are part of your job!

WELDING REPORT
Welding = N° 46 - NO ERROR

Date (dd/mm/yy) = 16/02/18
Time (hh:mm) = 09:46

Standard
ISO 21307 (06/11) SINGLE LP

Diameter = 250 mm
SDR = 17
Thickness = 14.8mm
Material = PE

pt = 0.17MPa
T min = 200°C
T nom = 223°C
T max = 245°C
p1 = 20 bar
A = 20mm
p2 = 0 bar, t2 = 163 s
t3 = 5 s
t4 = 8 s
p3 = 20 bar, t5 = 1080 s

Model = BASIC 315 (V0,V1)
Piston area = 6.68 cm²
Serial = 99000006
Firmware version = 216
Next overhaul (mm/yy) = 10/18
Operator = Test operator
Job site = Ritmo
Remark = test welding

Diameter = 250 mm
SDR = 17
Thickness = 14.8mm
Material = PE
T heater = 223°C

Drag pressure pt = 3 bar
p1 + pt = 31 bar, t1 = 30 s
p2 = 0 bar, t2 = 163 s
t3 = 4 s
t4 = 8 s
p3 + pt = 31 bar, t5 = 1080 s
t total = 1209 s

OPERATOR'S BADGE
300000941424312017564038002030

JOINT TRACEABILITY 1
313701110081452040602025320078232530012

JOINT TRACEABILITY 2
313701110081452040602025320078232530012

GPS 45:23,39647 11:43,0569

PICTURES BEFORE AFTER

***** REPORT n.9 Easy Life v1.09 *****

Date: 02/02/16
Hour: 12:58
Set temperature HP: 200 C
Revision: 11/15
Serial number: 111200000
Diameter: 75 mm
Material: PP
SDR: 7.4
Operator: GIA
Job site: RIT

Remark: *****
*** WELDING DATA ***
Welding number: 9
Drag Pressure: 5 bar
P1: 40 bar
P2: 2 bar
P5: 40 bar
T1: 2s
T2: 30s
T3: 6s
T4: 4s
T5: 180s
Total joint time: 3:42"

Report by EASY LIFE

Report by
EASY LIFE + "SET & GO! PRO"



BASIC 160 EASY LIFE

Self-aligning hydraulic butt fusion machine, suitable for welding under-pressure pipes for water, gas and other fluids up to $\varnothing 160$ mm 5" IPS. BASIC 160 EASY LIFE, thanks to a special gearcase, is able to manage the automated welding process. Built according to the International standards (UNI 10565, ISO 12176-1), BASIC 160 EASY LIFE includes:

- A machine body built with a supporting frame, four clamps and two hydraulic cylinders with fast non-drip coupling connections.
- A Teflon-coated (PTFE) heating plate with a built-in independent thermometer to check the working temperature.
- An extractable electric milling cutter to face the heads of the pipes and/or fittings. It includes a safety micro-switch and a thermal circuit breaker.
- An electro-hydraulic gearcase protected from crashes and atmospheric corrosion by a plastic box. The electronic system guarantees the continuous repeat of the welding cycles and automatic control of the preset parameters, therefore the operator needs only to validate the welding phases. **Easy Life is "Wi-Fi" ready and works together with the App "SET & GO PRO"**. The user-friendly graphic display allows a quick setting of the desired parameters. The EASY LIFE system can store up to 4000 welding cycles and sum them up into a PDF file. This report can be transferred to a PC/laptop through a USB port and data-management software. Possibility to pre-set 50 customized welding cycles. The EASY LIFE system data logging now shows the time!
- A milling cutter/ heating plate support

BASIC 160 EASY LIFE is able to weld fittings like elbows, tees, Y-branches and flanges necks.
Available in 230 V versions.

STANDARD COMPOSITION



Machine body



Gearcase



Heating plate



Milling cutter



Support

TECHNICAL FEATURES

PLUS

**AUTOMATED
WELDING
PROCESS**

Wi-Fi ready
App SET & GO - PRO

* Suggested power generator
5,5 ÷ 6kVA

| | |
|-------------------------------------|--|
| Working range | 40 ÷ 160 mm; 1" IPS ÷ 5" IPS |
| Materials | HDPE, PP, PP-R, PVDF For other materials contact RITMO S.P.A. |
| Power supply | 230 V Single Phase 50/60 Hz |
| Total absorbed power* | 3000 W |
| Working temperature | 180° ÷ 280° C (356° ÷ 536° F) |
| Outside temperature range | -10° ÷ 40° C (14° ÷ 104° F) |
| Time to reach welding temperature | < 20' |
| Memory | 4000 cycles |
| Pre-set welding cycles | 50 customized |
| Wi-Fi ready | App "SET & GO PRO" |
| Dimensions machine body (W x D x H) | 606 x 365 x 375 mm (24" x 14.5" x 15") |
| Dimensions gearcase (W x D x H) | 585 x 384 x 463 mm (23" x 15.1" x 18.2") |
| Weight machine body | 32 Kg (70.5 lb) |
| Weight standard composition | 88 Kg (194.1 lb) |

ON REQUEST



Inserts
Ø 40 ÷ 140 mm



Trolley



Rollers



App
"Set & Go Pro"

and:
Inserts Ø 1" ÷ 5" IPS; 3" ÷ 4" DIPS
pre-insulated bag for heating plate

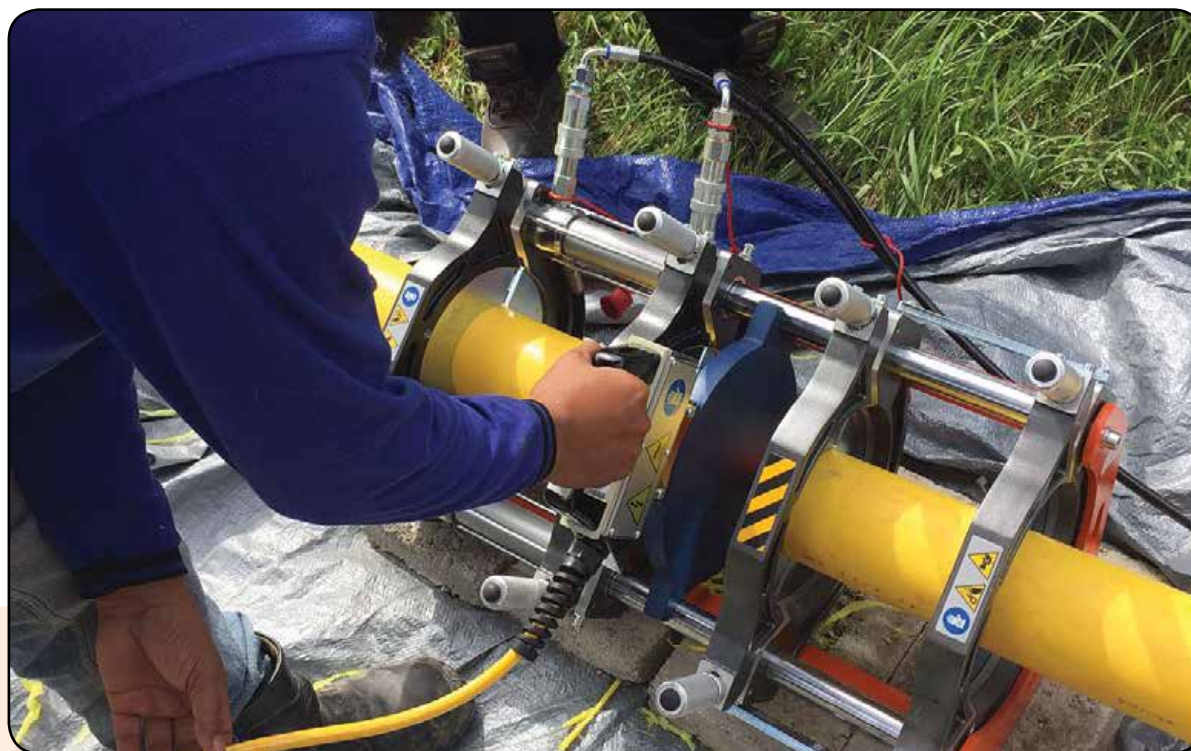



BASIC 200 EASY LIFE

Self-aligning hydraulic butt fusion machine, suitable for welding under-pressure pipes for water, gas and other fluids up to \varnothing 200 mm 6" DIPS. BASIC 200 EASY LIFE, thanks to a special gearcase, is able to manage the automated welding process. Built according to the International standards (UNI 10565, ISO 12176-1), BASIC 200 EASY LIFE includes:

- A machine body built with a supporting frame, four clamps and two hydraulic cylinders with fast non-drip coupling connections.
- A Teflon-coated (PTFE) heating plate with a built-in independent thermometer to check the working temperature.
- An extractable electric milling cutter to face the heads of the pipes and/or fittings. It includes a safety micro-switch and a thermal circuit breaker.
- An electro-hydraulic gearcase protected from crashes and atmospheric corrosion by a plastic box. The electronic system guarantees the continuous repeat of the welding cycles and automatic control of the preset parameters, therefore the operator needs only to validate the welding phases. **Easy Life is "Wi-Fi" ready and works together with the App "SET & GO PRO"**. The user-friendly graphic display allows a quick setting of the desired parameters. The EASY LIFE system can store up to 4000 welding cycles and sum them up into a PDF file. This report can be transferred to a PC/laptop through a USB port and data-management software. Possibility to pre-set 50 customized welding cycles. The EASY LIFE system data logging now shows the time!
- A milling cutter/ heating plate support

BASIC 200 EASY LIFE is able to weld fittings like elbows, tees, Y-branches and flanges necks. Available in 230 V versions.

STANDARD COMPOSITION



Machine body



Gearcase



Heating plate



Milling cutter



Support

TECHNICAL FEATURES

PLUS

**AUTOMATED
WELDING
PROCESS**

Wi-Fi ready
App SET & GO - PRO

* Suggested power generator
5,5 ÷ 6kVA

| | |
|-------------------------------------|--|
| Working range | 63 ÷ 200 mm; 2" IPS ÷ 6" DIPS |
| Materials | HDPE, PP, PP-R, PB, PVDF For other materials contact RITMO S.P.A. |
| Power supply | 230 V Single Phase 50/60 Hz |
| Total absorbed power* | 4100 W |
| Working temperature | 180° ÷ 280° C (356° ÷ 536° F) |
| Outside temperature range | -10° ÷ 40° C (14° ÷ 104° F) |
| Time to reach welding temperature | < 20' |
| Memory | 4000 cycles |
| Pre-set welding cycles | 50 customized |
| Wi-Fi ready | App "SET & GO PRO" |
| Dimensions machine body (W x D x H) | 685 x 460 x 420 mm (27" x 18" x 15.5") |
| Dimensions gearcase (W x D x H) | 585 x 384 x 463 mm (23" x 15.1" x 18.2") |
| Weight machine body | 39 Kg (86 lb) |
| Weight standard composition | 100 Kg (220,5 lb) |

ON REQUEST



Inserts
Ø 63 ÷ 180 mm



Trolley



Rollers



App
"Set & Go Pro"



Tool for flange
necks

and:
Inserts
Ø 2" ÷ 6" IPS; 3" ÷ 6" DIPS
pre-insulated bag
for heating plate





BASIC 250 EASY LIFE

Self-aligning hydraulic butt fusion machine, suitable for welding under-pressure pipes for water, gas and other fluids up to \varnothing 250 mm 8" DIPS. BASIC 250 EASY LIFE, thanks to a special gearcase, is able to manage the automated welding process. Built according to the International standards (UNI 10565, ISO 12176-1), BASIC 250 EASY LIFE includes:

- A machine body built with a supporting frame, four clamps and two hydraulic cylinders with fast non-drip coupling connections. It comes with the fast-locking-adapters system SMARTLock patented by Ritmo
- A Teflon-coated (PTFE) heating plate with a built-in independent thermometer to check the working temperature.
- An extractable electric milling cutter to face the heads of the pipes and/or fittings. It includes a safety micro-switch and a thermal circuit breaker.
- An electro-hydraulic gearcase protected from crashes and atmospheric corrosion by a plastic box. The electronic system guarantees the continuous repeat of the welding cycles and automatic control of the preset parameters, therefore the operator needs only to validate the welding phases. **Easy Life is "Wi-Fi" ready and works together with the App "SET & GO PRO"**. The user-friendly graphic display allows a quick setting of the desired parameters. The EASY LIFE system can store up to 4000 welding cycles and sum them up into a PDF file. This report can be transferred to a PC/laptop through a USB port and data-management software. Possibility to pre-set 50 customized welding cycles. The EASY LIFE system data logging now shows the time!
- A milling cutter/ heating plate support

BASIC 250 EASY LIFE is able to weld fittings like elbows, tees, Y-branches and flanges necks. Available in 230 V versions.

STANDARD COMPOSITION



Machine body



Detach device for heater



Gearcase



Heating plate



Milling cutter



Support

TECHNICAL FEATURES

PLUS

**AUTOMATED
WELDING
PROCESS**

Wi-Fi ready
App SET & GO - PRO

* Suggested power generator
5,5 ÷ 6kVA

| | |
|-------------------------------------|--|
| Working range | 75 ÷ 250 mm; 2" IPS ÷ 8" DIPS |
| Materials | HDPE, PP, PP-R, PB, PVDF For other materials contact RITMO S.P.A. |
| Power supply | 230 V Single Phase 50/60 Hz |
| Total absorbed power* | 4200 W |
| Working temperature | 180° ÷ 280° C (356° ÷ 536° F) |
| Outside temperature range | -10° ÷ 40° C (14° ÷ 104° F) |
| Time to reach welding temperature | < 20' |
| Memory | 4000 cycles |
| Pre-set welding cycles | 50 customized |
| Wi-Fi ready | App "SET & GO PRO" |
| Dimensions machine body (W x D x H) | 850 x 470 x 400 mm (33.5" x 18.5" x 16") |
| Dimensions gearcase (W x D x H) | 585 x 384 x 463 mm (23" x 15.1" x 18.2") |
| Weight machine body | 63 Kg (139 lb) |
| Weight standard composition | 132 Kg (291 lb) |

ON REQUEST



Inserts
Ø 75 ÷ 225 mm



Tool for flange
necks



Trolley for
machine body



App
"Set & Go Pro"



Top Clamp Short
Elbows/Tee



Rollers

and:

Inserts Ø 2" ÷ 8" IPS; 3" ÷ 8" DIPS
pre-insulated bag for heating plate, trolley for milling cutter/heating plate, wooden case for inserts

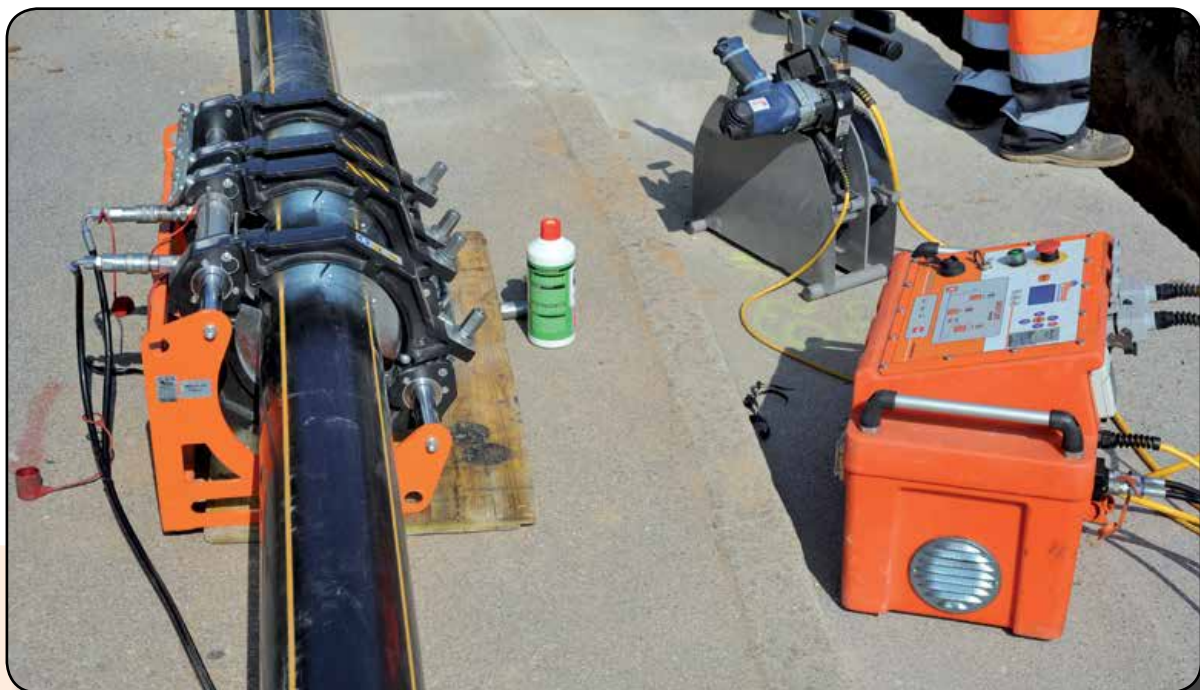



BASIC 315 EASY LIFE

Self-aligning hydraulic butt fusion machine, suitable for welding under-pressure pipes for water, gas and other fluids up to \varnothing 315 mm 10" DIPS. BASIC 315 EASY LIFE, thanks to a special gearcase, is able to manage the automated welding process. Built according to the International standards (UNI 10565, ISO 12176-1), BASIC 315 EASY LIFE includes:

- A machine body built with a supporting frame, four clamps and two hydraulic cylinders with fast non-drip coupling connections. It comes with the fast-locking-adapters system SMARTLock patented by Ritmo
- A Teflon-coated (PTFE) heating plate with a built-in independent thermometer to check the working temperature.
- An extractable electric milling cutter to face the heads of the pipes and/or fittings. It includes a safety micro-switch and a thermal circuit breaker.
- An electro-hydraulic gearcase protected from crashes and atmospheric corrosion by a plastic box. The electronic system guarantees the continuous repeat of the welding cycles and automatic control of the preset parameters, therefore the operator needs only to validate the welding phases. **Easy Life is "Wi-Fi" ready and works together with the App "SET & GO - PRO"**. The user-friendly graphic display allows a quick setting of the desired parameters. The EASY LIFE system can store up to 4000 welding cycles and sum them up into a PDF file. This report can be transferred to a PC/laptop through a USB port and data-management software. Possibility to pre-set 50 customized welding cycles. The EASY LIFE system data logging now shows the time!
- A milling cutter/ heating plate support

BASIC 315 EASY LIFE is able to weld fittings like elbows, tees, Y-branches and flanges necks. Available in 230 V versions.

STANDARD COMPOSITION



Machine body



Detach device for heater



Gearcase



Heating plate



Milling cutter



Support

TECHNICAL FEATURES

PLUS

**AUTOMATED
WELDING
PROCESS**

Wi-Fi ready
App SET & GO - PRO

* Suggested power generator
6,5 ÷ 7kVA

| | |
|-------------------------------------|--|
| Working range | 90 ÷ 315 mm; 3" IPS ÷ 10" DIPS |
| Materials | HDPE, PP, PP-R, PB, PVDF For other materials contact RITMO S.P.A. |
| Power supply | 230 V Single Phase 50/60 Hz |
| Total absorbed power* | 5050 W |
| Working temperature | 180° ÷ 280° C (356° ÷ 536° F) |
| Outside temperature range | -10° ÷ 40° C (14° ÷ 104° F) |
| Time to reach welding temperature | < 20' |
| Memory | 4000 cycles |
| Pre-set welding cycles | 50 customized |
| Wi-Fi ready | App "SET & GO PRO" |
| Dimensions machine body (W x D x H) | 981x 586 x 520 mm (38.6" x 23" x 20.5") |
| Dimensions gearcase (W x D x H) | 585 x 384 x 463 mm (23" x 15.1" x 18.2") |
| Weight machine body | 86 Kg (190 lb) |
| Weight standard composition | 174 Kg (383 lb) |

ON REQUEST



Inserts
Ø 90 ÷ 280mm
master Ø 250 mm



Tool for flange
necks



Trolley for
machine body



App
"Set & Go Pro"



Rollers

and:
Inserts Ø 3" ÷ 10" IPS; 3" ÷ 10" DIPS
pre-insulated bag for heating plate, trolley for milling cutter/heating plate, wooden case for inserts





BASIC 355 EASY LIFE

Self-aligning hydraulic butt fusion machines, suitable for welding under-pressure pipes for water, gas and other fluids. Built according to the International standards (UNI 10565, ISO 12176-1), BASIC 355 includes:

- A machine body built with a supporting frame, four clamps and two hydraulic cylinders with fast non-drip coupling connections. It comes with the fast-locking-adapters system SMARTLock patented by Ritmo
- A Teflon-coated (PTFE) heating plate with a built-in independent thermometer to check the working temperature.
- An extractable electric milling cutter to face the heads of the pipes and/or fittings. It includes a safety micro-switch and a thermal circuit breaker.
- An electro-hydraulic gearcase protected from crashes and atmospheric corrosion by a plastic box. The electronic system guarantees the continuous repeat of the welding cycles and automatic control of the preset parameters, therefore the operator needs only to validate the welding phases. **Easy Life is "Wi-Fi" ready and works together with the App "SET & GO PRO"**. The user-friendly graphic display allows a quick setting of the desired parameters. The EASY LIFE system can store up to 4000 welding cycles and sum them up into a PDF file. This report can be transferred to a PC/laptop through a USB port and data-management software. Possibility to pre-set 50 customized welding cycles. The EASY LIFE system data logging now shows the time!
- A milling cutter/ heating plate support

BASIC 355 is able to weld fittings like elbows, tees, Y-branches and flanges necks. Available in the 230 V versions.

STANDARD COMPOSITION



Machine body



Detach device for heater



Gearcase



Heating plate



Milling cutter



Support

TECHNICAL FEATURES

PLUS

**AUTOMATED
WELDING
PROCESS**

Wi-Fi ready
App SET & GO - PRO

* Suggested power generator
8 ÷ 8,5kVA

| | |
|-------------------------------------|--|
| Working range | 125 ÷ 355 mm; 4" IPS ÷ 14" IPS |
| Materials | HDPE, PP, PP-R, PB, PVDF For other materials contact RITMO S.P.A. |
| Power supply | 230 V Single Phase 50/60 Hz |
| Total absorbed power* | 5750 W |
| Working temperature | 180° ÷ 280° C (356° ÷ 536° F) |
| Outside temperature range | -10° ÷ 40° C (14° ÷ 104° F) |
| Time to reach welding temperature | < 20' |
| Memory | 4000 cycles |
| Pre-set welding cycles | 50 customized |
| Wi-Fi ready | App "SET & GO PRO" |
| Dimensions machine body (W x D x H) | 1077 x 510 x 715 mm (42,4" x 20" x 28") |
| Dimensions gearcase (W x D x H) | 585 x 384 x 463 mm (23" x 15.1" x 18.2") |
| Weight machine body | 100 Kg (220.5 lb) |
| Weight standard composition | 216 Kg (476 lb) |

ON REQUEST



Inserts
Ø 125 ÷ 315 mm
master Ø 250 mm



Tool for flange
necks



Trolley



App
"Set & Go Pro"



Rollers

and:
Inserts Ø 4" ÷ 12" IPS; 4" ÷ 12" DIPS master Ø 250 mm
pre-insulated bag for heating plate, wooden case for inserts





DELTA 500 EASY LIFE

This is a self-aligning machine, suitable for welding ducts for the transport of water, gas and other fluids under pressure, up to \varnothing 500 mm 18" DISP). The DELTA 500 was designed in accordance to the International correspondent standards (UNI 10565, ISO 12176-1), and consists of:

- A machine body with a steel bearing frame, four steel clamps and two hydraulic thrust cylinders with non-drip quick couplings and steel inserts.
- Self detaching device: helps removing the heating plate during welding procedure.
- An extractable heating plate with separate thermometer for reading the working temperature.
- An extractable electric milling cutter for leveling the ends of the pipe and/or fitting, with a safety microswitch and overload cutout. Milling cutter's plastic control box is protected by a metal frame, and equipped with a fast removing system to speed up the extraction from machine body.
- An electro-hydraulic gearcase protected from crashes and atmospheric corrosion by a plastic box. The electronic system guarantees the continuous repeat of the welding cycles and automatic control of the preset parameters, therefore the operator needs only to validate the welding phases. **Easy Life is "Wi-Fi" ready and works together with the App "SET & GO PRO"**. The user-friendly graphic display allows a quick setting of the desired parameters. The EASY LIFE system can store up to 4000 welding cycles and sum them up into a PDF file. This report can be transferred to a PC/laptop through a USB port and data-management software. Possibility to pre-set 50 customized welding cycles. The EASY LIFE system data logging now shows the time!
- A milling cutter/ heating plate support

With DELTA 500 it is possible to weld fittings such as elbows, tees, wyes and stub ends. This is possible because the 3rd clamp can be anchored to the 1st and 2nd (movable) and slide along with the pipe. The fitting have to be locked in the 4th clamp. Short neck stub ends can be welded with the help of a special tool (on request).

Available in 230 V and 400 V.

STANDARD COMPOSITION



Machine body



Detach device
for heater



Gearcase



Milling cutter

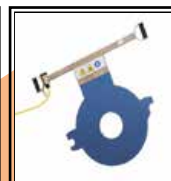

Heating plate

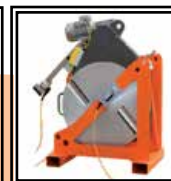

Support

TECHNICAL FEATURES

PLUS

**AUTOMATED
WELDING
PROCESS**

Wi-Fi ready
App SET & GO - PRO

* Suggested power generator
12kVA

| | |
|-------------------------------------|--|
| Working range | 200 ÷ 500 mm; 8" IPS ÷ 18" DIPS |
| Materials | HDPE, PP, PVDF For other materials contact RITMO S.P.A. |
| Power supply* | 230 Single Phase 50/60 Hz 400 V Three Phase 50/60 HZ |
| Total absorbed power | 7550 W (230 V) 7200 W (400 V) |
| Working temperature | 180° ÷ 280° C (356° ÷ 536° F) |
| Outside temperature range | -10° ÷ 40° C (14° ÷ 104° F) |
| Time to reach welding temperature | < 20' |
| Memory | 4000 cycles |
| Pre-set welding cycles | 50 customized |
| Wi-Fi ready | App "SET & GO PRO" |
| Dimensions machine body (W x D x H) | 1265 x 790 x 780 mm (50" x 31" x 31") |
| Dimensions gearcase (W x D x H) | 585 x 384 x 463 mm (23" x 15" x 18.5") |
| Weight machine body | 230 Kg (507 lb) |
| Weight standard composition | 418 Kg (921.5 lb) |

ON REQUEST

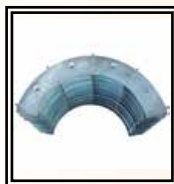

Inserts
Ø 200 ÷ 450 mm



Tool for flange
necks



Trolley



Electrical crane



Rollers



App
"Set & Go Pro"

and:

Inserts Ø 8" ÷ 18" IPS; 8" ÷ 18" DIPS

pre-insulated bag for heating plate, special transport wooden case or metal cage for:
body machine/trolley - gearcase/plate/cutter





DELTA 630 EASY LIFE

This is a self-aligning machine, suitable for welding ducts for the transport of water, gas and other fluids under pressure, up to \varnothing 630 mm - 24" IPS. The DELTA 630 was designed in accordance to the International correspondent standards (UNI 10565, ISO 12176-1), and consists of:

- A machine body with a steel bearing frame, four steel clamps and two hydraulic thrust cylinders with non-drip quick couplings and steel inserts.
- Self detaching device: helps removing the heating plate during welding procedure.
- An extractable heating plate with separate thermometer for reading the working temperature.
- An extractable electric milling cutter for leveling the ends of the pipe and/or fitting, with a safety microswitch and overload cutout. Milling cutter's plastic control box is protected by a metal frame, and equipped with a fast removing system to speed up the extraction from machine body.
- An electro-hydraulic gearcase protected from crashes and atmospheric corrosion by a plastic box. The electronic system guarantees the continuous repeat of the welding cycles and automatic control of the preset parameters, therefore the operator needs only to validate the welding phases. **Easy Life is "Wi-Fi" ready and works together with the App "SET & GO PRO"**. The user-friendly graphic display allows a quick setting of the desired parameters. The EASY LIFE system can store up to 4000 welding cycles and sum them up into a PDF file. This report can be transferred to a PC/laptop through a USB port and data-management software. Possibility to pre-set 50 customized welding cycles. The EASY LIFE system data logging now shows the time!
- A milling cutter/ heating plate support

With DELTA 630 it is possible to weld fittings such as elbows, tees, wyes and stub ends. This is possible because the 3rd clamp can be anchored to the 1st and 2nd (movable) and slide along with the pipe. The fitting have to be locked in the 4th clamp. Short neck stub ends can be welded with the help of a special tool (on request).

STANDARD COMPOSITION



Machine body



Detach device
for heater



Gearcase



Milling cutter

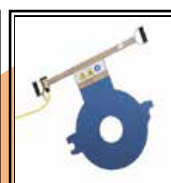

Heating plate

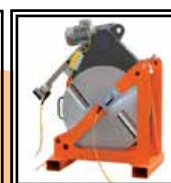

Support

TECHNICAL FEATURES

PLUS

**AUTOMATED
WELDING
PROCESS**

Wi-Fi ready
App SET & GO - PRO

* Suggested power generator
18kVA

| | |
|-------------------------------------|--|
| Working range | 280 ÷ 630 mm; 10" IPS ÷ 24" IPS |
| Materials | HDPE, PP, PVDF For other materials contact RITMO S.P.A. |
| Power supply* | 230 V three phase 50/60 HZ 400 V three phase 50/60 HZ |
| Total absorbed power | 12350 W |
| Working temperature | 180° ÷ 280° C (356° ÷ 536° F) |
| Outside temperature range | -10° ÷ 40° C (14° ÷ 104° F) |
| Time to reach welding temperature | < 20' |
| Memory | 4000 cycles |
| Pre-set welding cycles | 50 customized |
| Wi-Fi ready | App "SET & GO PRO" |
| Dimensions machine body (W x D x H) | 1550 x 1010 x 1000 mm (61" x 40" x 40") |
| Dimensions gearcase (W x D x H) | 1000 x 580 x 680 mm (39.5" x 23" x 27") |
| Weight machine body | 415 Kg (915 lb) |
| Weight standard composition | 700 Kg (1543 lb) |

ON REQUEST



Inserts
Ø 280 ÷ 560 mm



Tool for flange
necks



Trolley



Electrical crane



Hydraulic
Rollers



Rollers



App
"Set & Go Pro"

and:

Inserts Ø 10" ÷ 24" IPS; 10" ÷ 20" DIPS;

special transport wooden case or metal cage for body machine/trolley - gearcase/plate/cutter



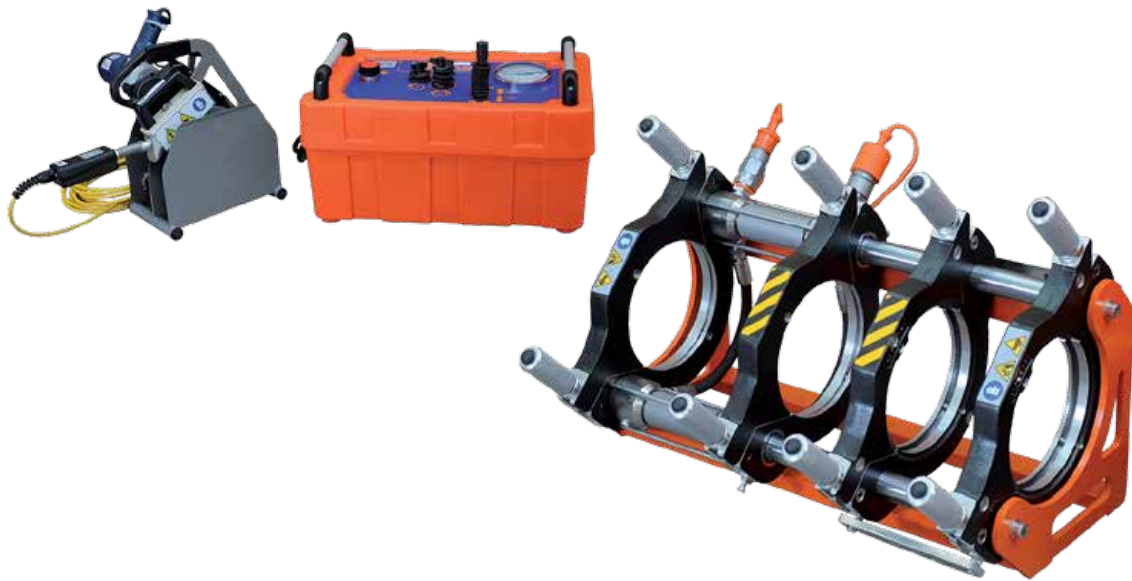

BASIC 160

Self-aligning hydraulic butt fusion machine, suitable for welding under-pressure pipes for water, gas and other fluids up to \varnothing 160 mm 5" IPS. Built according to the International standards (UNI 10565, ISO 12176-1), BASIC 160 includes:

- A machine body built with a supporting frame, four clamps and two hydraulic cylinders with fast non-drip coupling connections.
- A Teflon-coated (PTFE) heating plate with a built-in independent thermometer, to check the working temperature, and an high-precision electronic thermoregulator "Digital Dragon" ($\pm 1^\circ\text{C}$) with digital display and regulating buttons. This system includes Led indicators to check if the machine is working normally (live tension and working temperature), contingent probe's failures and/or temperature anomalies.
- An extractable electric milling cutter to face the heads of the pipes and/or fittings. It includes a safety micro-switch and a thermal circuit breaker.
- An electro-hydraulic gearcase protected from crashes and atmospheric corrosion by a plastic box. It includes a control lever, to open and close the clamps, maximum pressure and discharge valves (useful also for the "Dual Pressure" welding process), hydraulic connection hoses with non-drip fast couplings and timer (to check the warming and welding time). The machine is preset for the connection of the electronic controller THE INSPECTOR.
- A milling cutter/ heating plate support

BASIC 160 is able to weld fittings like elbows, tees, Y-branches and flanges necks.
Available in the 110 V and 230 V versions.

STANDARD COMPOSITION



Machine body



Gearcase



Heating plate
with Digital
Dragon



Milling cutter



Support

TECHNICAL FEATURES

PLUS

DIGITAL DRAGON

High-Precision
Electronic
Thermoregulator

* Suggested power generator
3,5 ÷ 4kVA

| | |
|-------------------------------------|--|
| Working range | 40 ÷ 160 mm; 1" IPS ÷ 5" IPS |
| Materials | HDPE, PP, PP-R, PVDF For other materials contact RITMO S.P.A. |
| Power supply | 110 V Single Phase 50/60 Hz 230 V Single Phase 50/60 Hz |
| Total absorbed power* | 2320 W (110 V) 2220 W (230 V) |
| Working temperature | 180° ÷ 280° C (356° ÷ 536° F) |
| Outside temperature range | -10° ÷ 40° C (14° ÷ 104° F) |
| Time to reach welding temperature | < 20' |
| Dimensions machine body (W x D x H) | 606 x 365 x 375 mm (24" x 14.5" x 15") |
| Weight machine body | 32 Kg (70.5 lb) |
| Weight standard composition | 77 Kg (170 lb) |

ON REQUEST



Inserts
Ø 40 ÷ 140 mm



Trolley



The INSPECTOR
Data-logging



Rollers



watch the video

and:
Inserts Ø 1" ÷ 5" IPS; 3" ÷ 4" DIPS
pre-insulated bag for heating plate

Italy

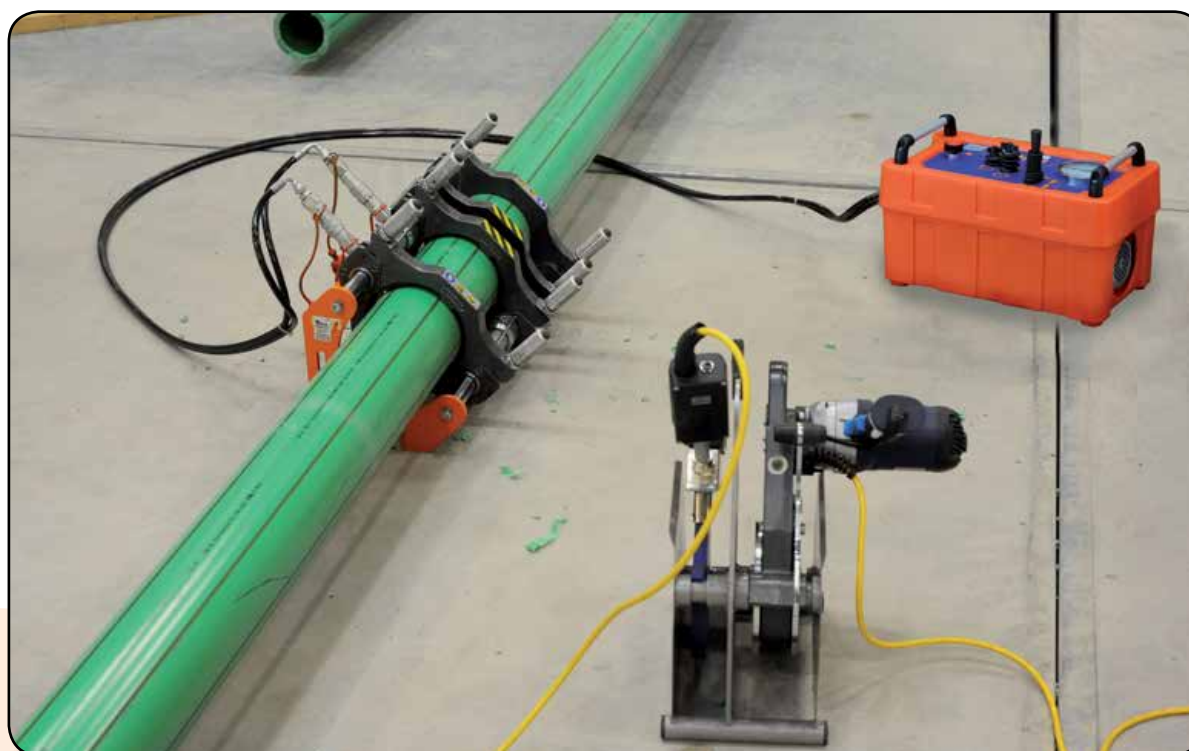

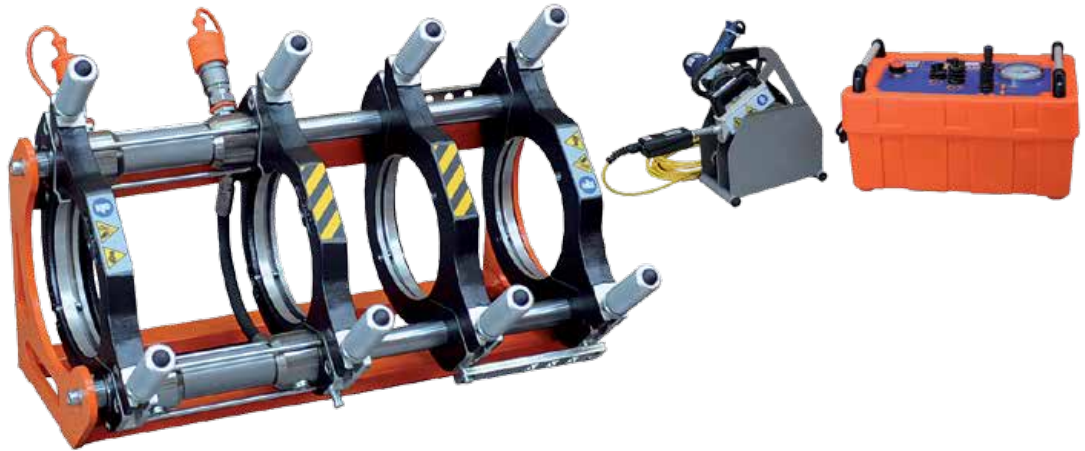

BASIC 200

Self-aligning hydraulic butt fusion machine, suitable for welding under-pressure pipes for water, gas and other fluids up to \varnothing 200 mm. Built according to the International standards (UNI 10565, ISO 12176-1), BASIC 100 includes:

- A machine body built with a supporting frame, four clamps and two hydraulic cylinders with fast non-drip coupling connections.
- A Teflon-coated (PTFE) heating plate with a built-in independent thermometer, to check the working temperature, and an high-precision electronic thermoregulator "Digital Dragon" ($\pm 1^\circ\text{C}$) with digital display and regulating buttons. This system includes Led indicators to check if the machine is working normally (live tension and working temperature), contingent probe's failures and/or temperature anomalies.
- An extractable electric milling cutter to face the heads of the pipes and/or fittings. It includes a safety micro-switch and a thermal circuit breaker.
- An electro-hydraulic gearcase protected from crashes and atmospheric corrosion by a plastic box. It includes a control lever, to open and close the clamps, maximum pressure and discharge valves (useful also for the "Dual Pressure" welding process), hydraulic connection hoses with non-drip fast couplings and timer (to check the warming and welding time). The machine is preset for the connection of the electronic controller THE INSPECTOR.
- A milling cutter/ heating plate support

BASIC 200 is able to weld fittings like elbows, tees, Y-branches and flanges necks.
Available in the 110 V and 230 V versions.

STANDARD COMPOSITION



Machine body



Gearcase



Heating plate
with Digital
Dragon



Milling cutter



Support

TECHNICAL FEATURES

PLUS

DIGITAL DRAGON

High-Precision
Electronic
Thermoregulator

* Suggested power generator
5,5 ÷ 6kVA

| | |
|-------------------------------------|--|
| Working range | 63 ÷ 200 mm; 2" IPS ÷ 6" DIPS |
| Materials | HDPE, PP, PP-R, PB, PVDF For other materials contact RITMO S.P.A. |
| Power supply* | 110 V Single Phase 50/60 Hz 230 V Single Phase 50/60 Hz |
| Total absorbed power | 3250 W |
| Working temperature | 180° ÷ 280° C (356° ÷ 536° F) |
| Outside temperature range | -10° ÷ 40° C (14° ÷ 104° F) |
| Time to reach welding temperature | < 20' |
| Dimensions machine body (W x D x H) | 685 x 460 x 420 mm (27" x 18" x 15.5") |
| Weight machine body | 39 Kg (86 lb) |
| Weight standard composition | 93 Kg (205 lb) |

ON REQUEST



Inserts
Ø 63 ÷ 180 mm



Tool for flange
necks



Trolley



The INSPECTOR
Data-logging



Rollers



watch the video

and:
Inserts Ø 2" ÷ 6" IPS; 3" ÷ 6" DIPS
pre-insulated bag for heating plate

Italy





BASIC 250

Self-aligning hydraulic butt fusion machines, suitable for welding under-pressure pipes for water, gas and other fluids. Built according to the International standards (UNI 10565, ISO 12176-1), BASIC 250 includes:

- A machine body built with a supporting frame, four clamps and two hydraulic cylinders with fast non-drip coupling connections. It comes with the fast-locking-adapters system SMARTLock patented by Ritmo
- A Teflon-coated (PTFE) heating plate with a built-in independent thermometer, to check the working temperature, and an high-precision electronic thermoregulator “Digital Dragon” ($\pm 1^{\circ}\text{C}$) with digital display and regulating buttons. This system includes Led indicators to check if the machine is working normally (live tension and working temperature), contingent probe’s failures and/or temperature anomalies.
- An extractable electric milling cutter to face the heads of the pipes and/or fittings. It includes a safety micro-switch and a thermal circuit breaker.
- An electro-hydraulic gearcase protected from crashes and atmospheric corrosion by a plastic box. It includes a control lever, to open and close the clamps, maximum pressure and discharge valves (useful also for the “Dual Pressure” welding process), hydraulic connection hoses with non-drip fast couplings and timer (to check the warming and welding time). The machine is preset for the connection of the electronic controller THE INSPECTOR.
- A milling cutter/ heating plate support

BASIC 250 is able to weld fittings like elbows, tees, Y-branches and flanges necks.
Available in the 110 V and 230 V versions.

STANDARD COMPOSITION



Machine body



Detach device
for heater



Gearcase



Heating plate
with Digital
Dragon



Milling cutter



Support

TECHNICAL FEATURES

PLUS

SMARTLOCK
PATENTED BY RITMO
fast-locking
adapters system

DIGITAL DRAGON
High-Precision
Electronic
Thermoregulator

* Suggested power generator
5,5 ÷ 6kVA

| | |
|-------------------------------------|--|
| Working range | 75 ÷ 250 mm; 2" IPS ÷ 8" DIPS |
| Materials | HDPE, PP, PP-R, PB, PVDF For other materials contact RITMO S.P.A. |
| Power supply* | 110 V Single Phase 50/60 Hz 230 V Single Phase 50/60 Hz |
| Total absorbed power | 3450 W |
| Working temperature | 180° ÷ 280° C (356° ÷ 536° F) |
| Outside temperature range | -10° ÷ 40° C (14° ÷ 104° F) |
| Time to reach welding temperature | < 20' |
| Dimensions machine body (W x D x H) | 850 x 470 x 400 mm (33.5" x 18.5" x 16") |
| Weight machine body | 63 Kg (139 lb) |
| Weight standard composition | 124 Kg (273.4 lb) |

ON REQUEST



Inserts
Ø 75 ÷ 225 mm



Tool for flange
necks



Trolley for
machine body



The INSPECTOR
Data-logging



Top Clamp Short
Elbows/Tee



Rollers



watch the video

and:

Inserts Ø 2" ÷ 8" IPS; 3" ÷ 8" DIPS

pre-insulated bag for heating plate, trolley for milling cutter/heating plate, wooden case for inserts

Italy





BASIC 315

Self-aligning hydraulic butt fusion machines, suitable for welding under-pressure pipes for water, gas and other fluids. Built according to the International standards (UNI 10565, ISO 12176-1), BASIC 315 includes:

- A machine body built with a supporting frame, four clamps and two hydraulic cylinders with fast non-drip coupling connections. It comes with the fast-locking-adapters system SMARTLock patented by Ritmo
- A Teflon-coated (PTFE) heating plate with a built-in independent thermometer, to check the working temperature, and an high-precision electronic thermoregulator "Digital Dragon" ($\pm 1^\circ\text{C}$) with digital display and regulating buttons. This system includes Led indicators to check if the machine is working normally (live tension and working temperature), contingent probe's failures and/or temperature anomalies.
- An extractable electric milling cutter to face the heads of the pipes and/or fittings. It includes a safety micro-switch and a thermal circuit breaker.
- An electro-hydraulic gearcase protected from crashes and atmospheric corrosion by a plastic box. It includes a control lever, to open and close the clamps, maximum pressure and discharge valves (useful also for the "Dual Pressure" welding process), hydraulic connection hoses with non-drip fast couplings and timer (to check the warming and welding time). The machine is preset for the connection of the electronic controller THE INSPECTOR.
- A milling cutter/ heating plate support

BASIC 315 is able to weld fittings like elbows, tees, Y-branches and flanges necks.
Available in the 110 V and 230 V versions.

STANDARD COMPOSITION



Machine body



Detach device
for heater



Gearcase



Heating plate
with Digital
Dragon



Milling cutter



Support

TECHNICAL FEATURES

PLUS

SMARTLOCK
PATENTED BY RITMO
fast-locking
adapters system

DIGITAL DRAGON
High-Precision
Electronic
Thermoregulator

* Suggested power generator
6,5 ÷ 7kVA

| | |
|-------------------------------------|--|
| Working range | 90 ÷ 315 mm; 3" IPS ÷ 10" DIPS |
| Materials | HDPE, PP, PP-R, PVDF For other materials contact RITMO S.P.A. |
| Power supply* | 110 V Single Phase 50/60 Hz 230 V Single Phase 50/60 Hz |
| Total absorbed power | 3900 W (110 V) 4500W (230 V) |
| Working temperature | 180° ÷ 280° C (356° ÷ 536° F) |
| Outside temperature range | -10° ÷ 40° C (14° ÷ 104° F) |
| Time to reach welding temperature | < 20' |
| Dimensions machine body (W x D x H) | 981 x 586 x 520 mm (37" x 23" x 20.5") |
| Weight machine body | 86 Kg (190 lb) |
| Weight standard composition | 166 Kg (366 lb) |

ON REQUEST



Inserts
Ø 90 ÷ 280 mm
master Ø 250 mm



Tool for flange
necks



Trolley for
machine body



The INSPECTOR
Data-logging



Rollers



watch the video

and:

Inserts Ø 3" ÷ 10" IPS; 3" ÷ 10" DIPS

pre-insulated bag for heating plate, trolley for milling cutter/heating plate, wooden case for inserts

Italy





BASIC 355

Self-aligning hydraulic butt fusion machines, suitable for welding under-pressure pipes for water, gas and other fluids. Built according to the International standards (UNI 10565, ISO 12176-1), BASIC 355 includes:

- A machine body built with a supporting frame, four clamps and two hydraulic cylinders with fast non-drip coupling connections. It comes with the fast-locking-adapters system SMARTLock patented by Ritmo
- A Teflon-coated (PTFE) heating plate with a built-in independent thermometer, to check the working temperature, and an high-precision electronic thermoregulator "Digital Dragon" ($\pm 1^\circ\text{C}$) with digital display and regulating buttons. This system includes Led indicators to check if the machine is working normally (live tension and working temperature), contingent probe's failures and/or temperature anomalies.
- An extractable electric milling cutter to face the heads of the pipes and/or fittings. It includes a safety micro-switch and a thermal circuit breaker.
- An electrohydraulic gearcase with a clamps opening and closing lever, maximum pressure and release valves (also useful when welding with the "Dual Pressure" procedure), hydraulic hoses with non-drip quick couplings, a timer (for the heating and welding phases). The machine is preset for the connection of the electronic controller THE INSPECTOR.
- A milling cutter/ heating plate support

BASIC 355 is able to weld fittings like elbows, tees, Y-branches and flanges necks.
Available in the 230 V versions.

STANDARD COMPOSITION



Machine body



Detach device
for heater



Gearcase



Heating plate
with Digital
Dragon



Milling cutter



Support

TECHNICAL FEATURES

PLUS

SMARTLOCK
PATENTED BY RITMO

fast-locking
adapters system

DIGITAL DRAGON

High-Precision
Electronic
Thermoregulator

* Suggested power generator
8 ÷ 8,5kVA

| | |
|-------------------------------------|--|
| Working range | 125 ÷ 355 mm; 4" IPS ÷ 14" IPS |
| Materials | HDPE, PP, PP-R, PVDF For other materials contact RITMO S.P.A. |
| Power supply* | 230 V Single Phase 50/60 Hz |
| Total absorbed power | 5750 W |
| Working temperature | 180° ÷ 280° C (356° ÷ 536° F) |
| Outside temperature range | -10° ÷ 40° C (14° ÷ 104° F) |
| Time to reach welding temperature | < 20' |
| Dimensions machine body (W x D x H) | 1077 x 510 x 715 mm (42.5" x 20" x 28") |
| Weight machine body | 100 Kg (220.5 lb) |
| Weight standard composition | 205 Kg (452 lb) |

ON REQUEST



Inserts
Ø 125 ÷ 315 mm
master Ø 250 mm



Tool for flange
necks



Trolley



The INSPECTOR
Data-logging



Rollers



watch the video

and:
Inserts Ø 4" ÷ 12" IPS; 4" ÷ 12" DIPS master Ø 250 mm
pre-insulated bag for heating plate, wooden case for inserts

Peru





DELTA 500

This is a self-aligning machine, suitable for welding ducts for the transport of water, gas and other fluids under pressure, up to \varnothing 500 mm 18" DISP). The DELTA 500 was designed in accordance to the International correspondent standards (UNI 10565, ISO 12176-1), and consists of:

- A machine body with a steel bearing frame, four steel clamps and two hydraulic thrust cylinders with non-drip quick couplings and steel inserts.
- Self detaching device: helps removing the heating plate during welding procedure.
- An extractable heating plate with separate thermometer for reading the working temperature.
- An extractable electric milling cutter for leveling the ends of the pipe and/or fitting, with a safety microswitch and overload cutout. Milling cutter's plastic control box is protected by a metal frame, and equipped with a fast removing system to speed up the extraction from machine body.
- An electrohydraulic gearcase with a clamps opening and closing lever, maximum pressure and release valves (also useful when welding with the "Dual Pressure" procedure), hydraulic hoses with non-drip quick couplings, a timer (for the heating and welding phases). The machine is preset for the connection of the electronic controller THE INSPECTOR.
- Digital electric connections box with the high precision ($\pm 1^\circ\text{C}$) "Digital Dragon" temperature controller protected by a special container and equipped with a reading display and keys for temperature adjustment.
- A milling cutter/heating plate support.

With DELTA 500 it is possible to weld fittings such as elbows, tees, wyes and stub ends. This is possible because the 3rd clamp can be anchored to the 1st and 2nd (movable) and slide along with the pipe. The fitting have to be locked in the 4th clamp. Short neck stub ends can be welded with the help of a special tool (on request). Available in 230 V and 400 V.

STANDARD COMPOSITION



Machine body



Detach device for heater



Gearcase



Electronic thermoregulator



Milling cutter

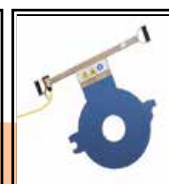

Heating plate



Support

TECHNICAL FEATURES

PLUS

**200 ÷ 500 mm
water - gas - oil**

**FACER
fast removing system**

“DIGITAL DRAGON”

* Suggested power generator
12kVA

| | |
|-------------------------------------|--|
| Working range | 200 ÷ 500 mm; 8" IPS ÷ 18" DIPS |
| Materials | HDPE, PP, PVDF For other materials contact RITMO S.P.A. |
| Power supply* | 230 Single Phase 50/60 Hz 400 V Three Phase 50/60 HZ |
| Total absorbed power | 7950 W (230 V) 7200 W (400 V) |
| Working temperature | 180° ÷ 280° C (356° ÷ 536° F) |
| Outside temperature range | -10° ÷ 40° C (14° ÷ 104° F) |
| Time to reach welding temperature | < 20' |
| Dimensions machine body (W x D x H) | 1265 x 790 x 780 mm (50" x 31" x 31") |
| Weight machine body | 230 Kg (507 lb) |
| Weight standard composition | 408 Kg (900 lb) |

ON REQUEST



Inserts
Ø 200 ÷ 450 mm



Tool for flange
necks

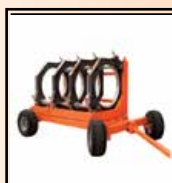

Trolley



Electrical crane



The INSPECTOR
Data-logging



Rollers

and:

Inserts Ø 8" ÷ 18" IPS; 8" ÷ 18" DIPS

pre-insulated bag for heating plate, special transport wooden case or metal cage for:
body machine/trolley - gearcase/plate/cutter

Russia





DELTA 630

This is a self-aligning machine, suitable for welding ducts for the transport of water, gas and other fluids under pressure, up to \varnothing 630 mm - 24" IPS. The DELTA 630 was designed in accordance to the International correspondent standards (UNI 10565, ISO 12176-1), and consists of:

- A machine body with a steel bearing frame, four steel clamps and two hydraulic thrust cylinders with non-drip quick couplings and steel inserts.
- Self detaching device: helps removing the heating plate during welding procedure.
- An extractable heating plate with separate thermometer for reading the working temperature.
- An extractable electric milling cutter for leveling the ends of the pipe and/or fitting, with a safety microswitch and overload cutout. Milling cutter's plastic control box is protected by a metal frame, and equipped with a fast removing system to speed up the extraction from machine body.
- An electrohydraulic gearcase with a clamps opening and closing lever, maximum pressure and release valves (also useful when welding with the "Dual Pressure" procedure), hydraulic hoses with non-drip quick couplings, a timer (for the heating and welding phases). The machine is preset for the connection of the electronic controller THE INSPECTOR.
- Digital electric connections box with the high precision ($\pm 1^\circ\text{C}$) "Digital Dragon" temperature controller protected by a special container and equipped with a reading display and keys for temperature adjustment.
- A milling cutter/heating plate support.

With DELTA 630 it is possible to weld fittings such as elbows, tees, wyes and stub ends. This is possible because the 3rd clamp can be anchored to the 1st and 2nd (movable) and slide along with the pipe. The fitting have to be locked in the 4th clamp. Short neck stub ends can be welded with the help of a special tool (on request).

STANDARD COMPOSITION



Machine body



Detach device for heater



Gearcase



Electronic thermoregulator



Milling cutter

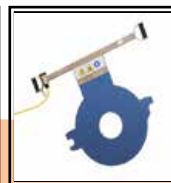

Heating plate



Support

TECHNICAL FEATURES

PLUS

**280 ÷ 630 mm
water - gas - oil
FACER
fast removing system**

“DIGITAL DRAGON”

* Suggested power generator
18kVA

| | |
|-------------------------------------|--|
| Working range | 280 ÷ 630 mm; 10" IPS ÷ 24" IPS |
| Materials | HDPE, PP, PVDF For other materials contact RITMO S.P.A. |
| Power supply* | 230 V three phase 50/60 HZ 400 V three phase 50/60 HZ |
| Total absorbed power | 12350 W |
| Working temperature | 180° ÷ 280° C (356° ÷ 536° F) |
| Outside temperature range | -10° ÷ 40° C (14° ÷ 104° F) |
| Time to reach welding temperature | < 20' |
| Dimensions machine body (W x D x H) | 1550 x 1010 x 1000 mm (61" x 40" x 40") |
| Weight machine body | 415 Kg (915 lb) |
| Weight standard composition | 708 Kg (1560 lb) |

ON REQUEST



Inserts
Ø 280 ÷ 560 mm



Tool for flange
necks



Trolley



Electrical crane



The INSPECTOR
Data-logging



Hydraulic
Rollers



Rollers

and:

Inserts Ø 10" ÷ 24" IPS; 10" ÷ 20" DIPS;
special transport wooden case or metal cage for body machine/trolley - gearcase/plate/cutter

Brazil





DELTA 800

This is a self-aligning machine, suitable for welding ducts for the transport of water, gas and other fluids under pressure, up to \varnothing 800 mm 30" IPS. The DELTA 800 was designed in accordance to the International correspondent standards (UNI 10565, ISO 12176-1), and consists of:

- A machine body with a bearing frame, four clamps and two hydraulic thrust cylinders with non-drip quick couplings, and steel inserts.
- An extractable heating plate with separate thermometer for reading the working temperature.
- An extractable electrically controlled milling cutter for levelling the ends of the pipe and/or fitting, with a safety microswitch and overload cutout.
- An electrohydraulic gearcase with a clamp opening and closing lever, maximum pressure and discharge valves (useful also during the "Dual Pressure" welding), hydraulic hoses with non-drip quick couplings, a timer (for the heating and welding phases), an extractable electrical panel with power outlet for the heating plate, an electronic thermoregulator for the control of the working temperature, a differential circuit breaker, and a special connection for the electronic data-logging THE INSPECTOR.
- A milling cutter/heating plate support.

The DELTA 800 can weld fittings such as bends, tees, branches and flange necks. This is possible because the 3rd clamp can be anchored to the 1st and 2nd (movable) and slide along with the pipe. The fitting must be locked in the 4th clamp. Necks with a highly reduced tang can be welded with the help of a special tool (on request), applied to the clamps.

STANDARD COMPOSITION



Machine body



Detach device for heater



Gearcase



Electronic thermoregulator



Milling cutter

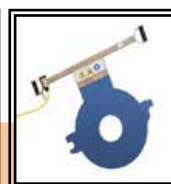

Heating plate



Support

TECHNICAL FEATURES

PLUS

**500 ÷ 800 mm
water - gas - oil
FACER
fast removing system**

“DIGITAL DRAGON”

* Suggested power generator
30kVA

| | |
|-------------------------------------|--|
| Working range | 500 ÷ 800 mm 20" IPS ÷ 30" IPS |
| Materials | HDPE, PP, PVDF For other materials contact RITMO S.P.A. |
| Power supply* | 400 V 3F+N+PE 50/60 HZ |
| Total absorbed power | 16500 W |
| Working temperature | 180° ÷ 280° C (356° ÷ 536° F) |
| Outside temperature range | -10° ÷ 40° C (14° ÷ 104° F) |
| Time to reach welding temperature | < 45' |
| Dimensions machine body (W x D x H) | 2100 x 1350 x 1300 mm (83" x 53" x 51") |
| Weight machine body | 821 Kg (1810 lb) |
| Weight standard composition | 1260 Kg (2777 lb) |

ON REQUEST



Inserts
Ø 500 ÷ 710 mm



Tool for flange
necks

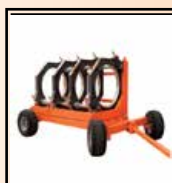

Trolley



Electrical crane



The INSPECTOR
Data-logging



Rollers

and:

Inserts Ø 20" ÷ 30" IPS; 18" ÷ 24" DIPS

Israel



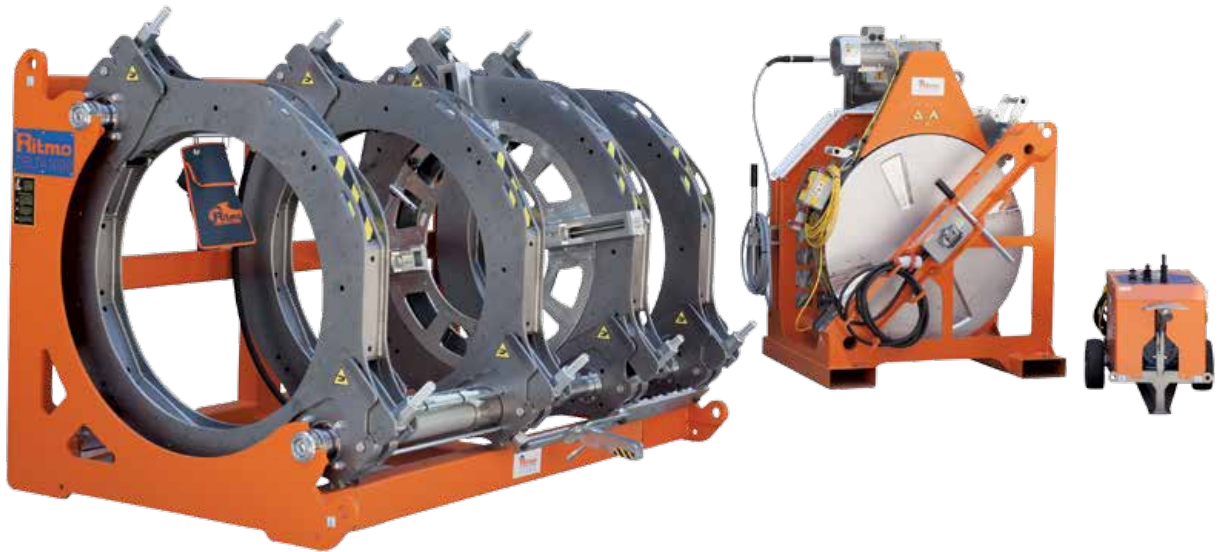

DELTA 1000

This is a self-aligning machine, suitable for welding ducts for the transport of water and other fluids under pressure, up to \varnothing 1000 mm - 36" IPS. The DELTA 1000 was designed in accordance to the International correspondent standards (UNI 10565, ISO 12176-1), and consists of:

- Machine body with a bearing frame, four steel clamps and two hydraulic thrust cylinders with non-drip quick couplings and steel inserts.
- Extractable heating plate with separate thermometer for reading the working temperature.
- Extractable electrically controlled milling cutter (with self detaching device) for levelling the ends of the pipe and/or fitting, with a safety microswitch, overload cut out, and emergency push button.
- Electrohydraulic gearcase with a clamp opening and closing lever, maximum pressure and discharge valves (useful also during the "Dual Pressure" welding), hydraulic hoses with non-drip quick couplings, a timer (for the heating and welding phases) and an electrical panel with a differential circuit breaker.
- Milling cutter/heating plate support with an electronic thermoregulator for the control of the working temperatures.

Holes on the chassis to hook the machine for a rapid and easier handling.

DELTA 1000 can weld fittings such as bends, tees, branches and flange necks. This is possible because the 3rd clamp can be anchored to the 1st and 2nd (movable) and slide along with the pipe. The fitting must be locked in the 4th clamp. Necks with a highly reduced tang can be welded with the help of a special tool (on request), applied to the clamps.

STANDARD COMPOSITION



Machine body



Detach device for heater



Gearcase



Electronic thermoregulator



Milling cutter

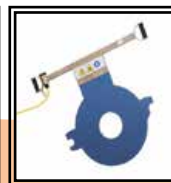

Heating plate



Support

TECHNICAL FEATURES

PLUS

630 ÷ 1000 mm

**HOLE FOR RAPID
AND EASIER
HANDLING**

* Suggested power generator
40kVA

| | |
|-------------------------------------|---|
| Working range | 630 ÷ 1000 mm; 24" IPS ÷ 36" IPS |
| Materials | HDPE, PP, For other materials contact RITMO S.P.A. |
| Power supply* | 400 V 3F+N+PE 50/60 HZ |
| Total absorbed power | 25000 W |
| Working temperature | 180° ÷ 280° C (356° ÷ 536° F) |
| Outside temperature range | -10° ÷ 40° C (14° ÷ 104° F) |
| Time to reach welding temperature | < 45' |
| Dimensions machine body (W x D x H) | 2386 x 1746 x 1711 mm (94" x 69" x 67") |
| Weight machine body | 2090 Kg (4607 lb) |
| Weight standard composition | 2942 Kg (6486 lb) |

ON REQUEST



Inserts
Ø 630 ÷ 900 mm



Tool for flange
necks



Trolley



Electrical crane



The INSPECTOR
Data-logging



Rollers

and:
Inserts Ø 24" ÷ 36" IPS

Oman





DELTA 1200 and DELTA 48"

Self-aligning welding machines, suitable for welding HDPE pipes and ducts for the transport of water and other fluids under pressure, up to Ø 1200 (Delta 1200) 48" IPS (DELTA 48"). The DELTA 1200 and DELTA 48" were designed in accordance to international standards (UNI 10565, ISO 12176-1), and consists of:

- Machine body with a bearing frame, four steel clamps and two hydraulic thrust cylinders with non-drip quick couplings and steel inserts.
- Extractable heating plate with separate thermometer for reading the working temperature.
- Extractable electrically controlled milling cutter (with self detaching device) for levelling the ends of the pipe and/or fitting, with a safety microswitch, overload cut out, and emergency push button.
- Electrohydraulic gearcase with a clamp opening and closing lever, maximum pressure and discharge valves (useful also during the "Dual Pressure" welding), hydraulic hoses with non-drip quick couplings, a timer (for the heating and welding phases) and an electrical panel with a differential circuit breaker.
- Milling cutter/heating plate support with an electronic thermoregulator for the control of the working temperatures.

Holes on the chassis to hook the machine for a rapid and easier handling.

DELTA 1200 and DELTA 48" can weld fittings such as elbows, tees, branches and flange necks. This is possible because the 3rd clamp can be anchored to the 1st and 2nd (movable) and slide along with the pipe. The fitting must be locked in the 4th clamp. Necks with a highly reduced tang can be welded with the help of a special tool (on request), applied to the clamps.

STANDARD COMPOSITION



Machine body



Detach device
for heater



Gearcase



Electronic
thermoregulator



Milling cutter

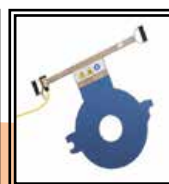

Heating plate



Support

TECHNICAL FEATURES

PLUS

DELTA 1200
710 ÷ 1200 mm

DELTA 48"
28" IPS ÷ 48" IPS

MASTER 1000 mm

* Suggested power generator
50kVA

| | |
|-------------------------------------|--|
| Working range | DELTA 1200 710 ÷ 1200 mm |
| | DELTA 48" 28" IPS ÷ 48" IPS |
| Materials | HDPE, PP For other materials contact RITMO S.P.A. |
| Power supply* | 400 V 3F+N+PE 50/60 HZ |
| Total absorbed power | 28200 W |
| Working temperature | 180° ÷ 280° C (356° ÷ 536° F) |
| Outside temperature range | -10° ÷ 40° C (14° ÷ 104° F) |
| Time to reach welding temperature | < 45' |
| Dimensions machine body (W x D x H) | 2465 x 1870 x 1900 mm (97" x 73.5" x 75") |
| Weight machine body | 2500 Kg (5510 lb) |
| Weight trolley | 830 Kg (1830 lb) |

ON REQUEST



Inserts **Delta 1200** Tool for flange
Ø 710 ÷ 1100 mm necks
Master Ø 1000 mm



Trolley for
machine body



Electrical crane



The **INSPECTOR**
Data-logging



Rollers

Delta 48"
Ø 28" ÷ 48" IPS;
Ø 30" ÷ 42" DIPS

and Trolley for support Heating Plate/Facer

Venezuela





DELTA 1600 ECO

Self-aligning welding machines, suitable for welding HDPE pipes and ducts for the transport of water and other fluids under pressure, up to \varnothing 1600.

DELTA 1600 ECO is designed in accordance to international standards (UNI 10565, ISO 12176-1), and consists of:

- Machine body with a bearing frame, four steel clamps and two hydraulic thrust cylinders with non-drip quick couplings and steel inserts.
- Extractable heating plate with separate thermometer for reading the working temperature.
- Extractable electrically controlled milling cutter (with self detaching device) for levelling the ends of the pipe and/or fitting, with a safety microswitch, overload cut out, and emergency push button.
- Electrohydraulic gearcase with a clamp opening and closing lever, maximum pressure and discharge valves (useful also during the "Dual Pressure" welding), hydraulic hoses with non-drip quick couplings, a timer (for the heating and welding phases) and an electrical panel with a differential circuit breaker.
- Milling cutter/heating plate support with an electronic thermoregulator for the control of the working temperatures.

Holes on the chassis to hook the machine for a rapid and easier handling.

DELTA 1600 ECO welds fittings such as elbows, tees, branches and flange necks. This is possible because the 3rd clamp can be anchored to the 1st and 2nd (movable) and slide along with the pipe. The fitting must be locked in the 4th clamp. Necks with a highly reduced tang can be welded with the help of a special tool (on request), applied to the clamps.

STANDARD COMPOSITION



Machine body



Detach device for heater



Gearcase



Electronic thermoregulator



Milling cutter

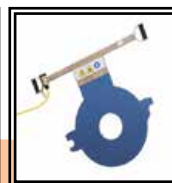

Heating plate



Support

TECHNICAL FEATURES

PLUS

800 ÷ 1600 mm

MASTER 1000 mm

HOLE FOR RAPID
AND EASIER
HANDLING

| | |
|-------------------------------------|--|
| Working range | 800 ÷ 1600 mm |
| Materials | HDPE, PP For other materials contact RITMO S.P.A. |
| Power supply | 400 V 3F+N+PE 50/60 HZ |
| Total absorbed power | 55000 W |
| Working temperature | 180° ÷ 280° C (356° ÷ 536° F) |
| Outside temperature range | -10° ÷ 40° C (14° ÷ 104° F) |
| Time to reach welding temperature | < 45' |
| Dimensions machine body (W x D x H) | 3534 x 2236 x 2226 mm (139,1" x 88" x 87,6") |
| Weight machine body | 4100 Kg (9040 lb) |
| Weight standard composition | 6000 Kg (13.230 lb) |

ON REQUEST



Ø 800 ÷ 1400 mm
Master Ø 1200 mm
Tool for flange
necks



Working area



Electrical crane



The INSPECTOR
Data-logging





DELTA 1600 HDR

This is a self-aligning welding machine with hydraulic clamps suitable for welding HDPE pipes for the transport of water and other fluids under pressure, up to \varnothing 1600 mm.

The DELTA 1600 HDR is designed in accordance to International standards (UNI 10565, ISO 12176-1). The DELTA 1600 HDR can weld fittings such as elbows, tees, branches and flange necks.

- Robust machine body made of steel
- Steel hydraulic clamping
- Automatic detaching device of heating plate
- Raised platform deck for perfect monitoring of fusion process
- Easy to operate control panel
- THE INSPECTOR data-logging compatible
- On board hydraulic control gearcase
- Pressure adjustment and pressure release valves for easy operations
- Hydraulically controller facer with safety microswitch
- Teflon coated heating plate with independent thermometer



STANDARD COMPOSITION



Machine body



Detach device for heater



Hydraulic clamps



Working area



Milling cutter

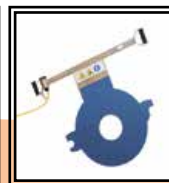

Heating plate



Support

TECHNICAL FEATURES

PLUS

800 ÷ 1600 mm

**HYDRAULIC
CLAMPS
and ROLLERS**

**HEAVY DUTY
CHASSIS 4,8 Ton**

| | |
|---|--|
| Working range | 800 ÷ 1600 mm; 32" IPS ÷ 60" DISP |
| Materials | HDPE, PP For other materials contact RITMO S.P.A. |
| Power supply* | 400 V 3F+N+PE 50/60 HZ |
| Total absorbed power | 45000 W |
| Working temperature | 180° ÷ 280° C (356° ÷ 536° F) |
| Outside temperature range | -10° ÷ 40° C (14° ÷ 104° F) |
| Dimensions machine body (W x D x H) | 3550 x 2400 x 2550 mm (140" x 94.4" x 100.5") |
| Weight machine body | 4800 Kg (10585 lb) |
| Weight milling cutter/heating plate/support | 1580 Kg (3485 lb) |

* Suggested power generator
75kVA

ON REQUEST



Inserts
Ø 800 ÷ 1400 mm



Tool for flange
necks



Trolley



The INSPECTOR
Data-logging



Hydraulic Rollers



watch the video

and:
Inserts Ø 32" ÷ 54" IPS; 30" ÷ 60" DIPS

Bahrein

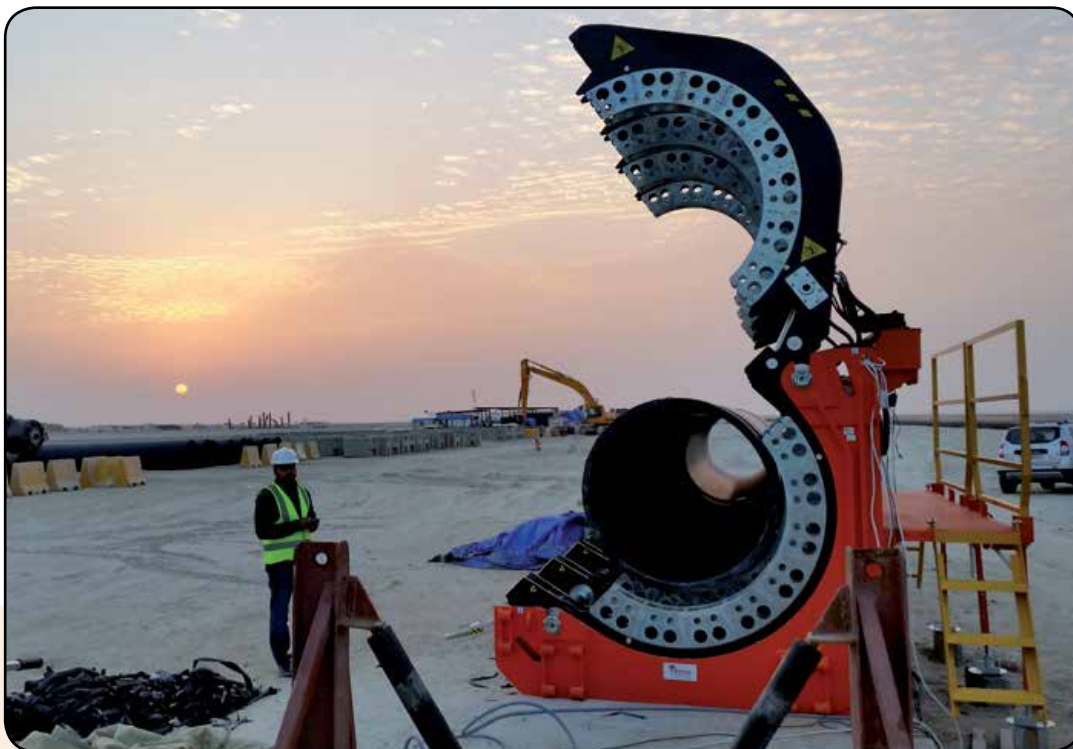



DELTA DRAGON CNC

Butt fusion welding can be managed automatically by using the Delta Dragon CNC system; this would eliminate any risk of error due to the operator. It is available in two versions: **SA with manual extraction of heating plate, FA with integrated mechanical extraction of heating plate.**

The CNC system is available for two machines: Delta Dragon 250 and 315. The gearcase it is equipped with a compact and innovative plastic casing, which can resist to the most extreme job site working conditions; particular attention was paid to the connections as well, by applying military type plugs. An easy to use software and control panel allow to view the most widely used welding standards (ISO, GIS, DVS and other). By selecting any one of the standard and pipe diameter/SDR, all the welding parameters (pressure, time, temperature) would be automatically calculated according to the standard itself. If the chosen welding cycle is not included in the standards listed above, it is possible to manually input the welding parameters (diameter, SDR, type of material, welding time and pressure...) by simply entering the "out of standard" mode. In both cases, the machine is able to automatically manage all the phases of the welding cycle, including milling and heating control. At the end of the welding cycle, all data are stored in the in-built memory, up to 4000 records. Serial ports enable the operator to connect the gearcase to a portable serial printer (to obtain an immediate report) or to a PC. The gearcase is equipped with GPS, USB port for welding report in PDF and to firmware upgrade.

The complete configuration includes:

- a linear transducer applied to the machine body
- a manually extractable heating element (SA) or an automatically extractable heating element (FA)
- hydraulic hoses with non-drip quick couplings for connecting the gearcase to the machine body
- a milling cutter
- a transducer cable for connecting the gearcase to the machine body
- a milling cutter/heating plate support

ON REQUEST



Inserts smartlock
Ø 75 ÷ 225 mm
Ø 90 ÷ 280 mm



Tool for flange
necks



Bar code reader



Rollers

PLUS

GPS
CNC
ELIMINATE
ANY
RISK OF ERROR

TECHNICAL FEATURES

| | DELTA DRAGON CNC 250 | DELTA DRAGON CNC 315 |
|-------------------------------------|--|--|
| Working range | 75 ÷ 250 mm | 90 ÷ 315 mm |
| Materials | HDPE, PP, PB, PVDF For other materials contact RITMO S.P.A. | HDPE, PP, PB, PVDF For other materials contact RITMO S.P.A. |
| Power supply* | 110 Vac 50/60 HZ 230 Vac 50/60 HZ | 110 Vac 50/60 HZ 230 Vac 50/60 HZ |
| Total absorbed power | 4000 W (110 V) 4150 W (230 V) | 4500 W (110 V) 5150 W (230 V) |
| Welding cycle | Semi-Automatic Fully-Automatic | Semi-Automatic Fully-Automatic |
| Memory capacity | 4000 welding cycles | 4000 welding cycles |
| Dimensions machine body (W x D x H) | 1000 x 820 x 1000 mm | 1150 x 970 x 1170 mm |
| Dimensions gearcase (W x D x H) | 580 x 461 x 490 mm 22.8" x 18.2" x 19.3" | 580 x 461 x 490 mm 22.8" x 18.2" x 19.3" |
| Weight machine body | 90 Kg (198.5 lb) | 125 Kg (275.6 lb) |
| Weight gearcase | 39 Kg (86 lb) | 39 Kg (86 lb) |
| Protection degree | IP 54 | IP 54 |

* Suggested power generator
6,5 ÷ 7kVA

* Suggested power generator
8 ÷ 8,5kVA



INTUITIVE CONTROL PANEL
GPS
LARGE GRAPHIC DISPLAY
EASY TO USE
USB PORT
REPORT PDF

Italy



ALL TERRAIN LINE - TRAILER LINE

HIGH LEVEL PERFORMANCE



DIFFERENCES BETWEEN ALL TERRAIN LINE AND TRAILER LINE

PLUS

**HIGH
PERFORMANCE**

**ENHANCES
PRODUCTIVITY**

| | ALL TERRAIN LINE | TRAILER LINE |
|--|------------------|--------------|
| Working standards mm | √ | √ |
| Working standards "IPS /"DIPS | √ | √ |
| International standards ISO 21307 HIGH PRESSURE | √ | √ |
| Welds fittings | √ | √ |
| Easy Life Welding System | √ | √ |
| Data-logging | √ | √ |
| Wi-Fi Ready | √ | √ |
| PRE-SET 20 customized welding cycles | √ | √ |
| Intuitive control panel | √ | √ |
| GPS traceability | √ | √ |
| Report PDF | √ | √ |
| Self-contained Generator on-board | √ | - |
| Heater/Facer on-board | √ | √ |
| Insert - Fast-locking system | √ | √ |
| Trolley with wheels | √ | √ |
| Self-propelled | √ | - |
| Remotely wire-controlled up to 12 m (39 ft) | √ | √ |
| Carriage can be removed for in-ditch use | √ | √ |
| Lateral rollers | √ | √ |





DELTA 250 TRAILER

Self-aligning hydraulic butt fusion machine, suitable for welding underpressure pipes for water, gas and other fluids up to \varnothing 250 mm (8" DIPS). Built according to the International standards ISO 21307 HIGH PRESSURE.

DELTA 250 TRAILER includes:

- A trailer-mounted machine body, easily removable from the trolley in order to perform also into the ditch, adapting to the conditions of the job site. It comes with the fast-locking adapters system SMARTLock RITMO Patented, thanks to which is possible to change adapters in few seconds.
- An on-board electric milling cutter that is equipped with a safety microswitch to prevent from accidental starts, a thermal circuit breaker to protect the engine and also features an ergonomic docking system and on/off switches. To allow the weld in ditches, the milling cutter is easily removable from the trolley/machine body in order to reduce the overall dimensions of the machine and ease the load/unload process.
- An extractable heating plate Teflon-coated (PTFE) equipped with an independent thermometer to check the working temperature.
- An EASY LIFE control panel which is also removable from the machine body to be able to check the welding phases outside from the ditches. It allows the operator to program and pilot all the welding duty cycle in an easy, fast and very intuitive way. It also controls the temperature of the heating plate, always visible on the display. It includes GPS and a data-logging system to store the welding data; USB port for download welding report PDF, or a printer ESC-POS connection, or firmware upgrade. The EASY LIFE system can store up to 4000 joint reports. Possibility to pre-set 20 customized welding cycles. **Easy Life system is "Wi-Fi" ready and works together with the App "SET & GO PRO".**
- A heating plate support which comes with a high-temperature-proof bag, which also avoid the heating element from being scratched.

DELTA 250 TRAILER is able to weld fittings like elbows, tees, Y-branches and flanges necks.
Available in the 110 V and 230 V versions.

STANDARD COMPOSITION



Machine body



Detach device for heater



Trolley



Control panel with GPS



Milling cutter

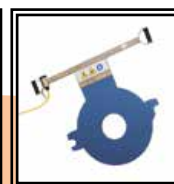

Heating plate

TECHNICAL FEATURES

PLUS

**75 ÷ 250 mm
water - gas - oil**

**SMARTLOCK
fast-locking adapters
system Ritmo
patented**

* Suggested power generator
5,5 ÷ 6kVA

| | |
|-------------------------------------|--|
| Working range | 75 ÷ 250 mm; 2" IPS ÷ 8" DIPS |
| Materials | HDPE, PP, PB, PVDF For other materials contact RITMO S.P.A. |
| Power supply* | 110 V Single Phase 50/60 Hz 230 V Single Phase 50/60 Hz |
| Total absorbed power | 4400 W (110 V) 4200 W (230 V) |
| Working temperature | 180° ÷ 280° C (356° ÷ 536° F) |
| Outside temperature range | -10° ÷ 40° C (14° ÷ 104° F) |
| Time to reach welding temperature | < 20' |
| Dimensions machine body (W x D x H) | 1080 x 1380 x 1330 mm 42.5" x 54.3" x 52,4" |
| Weight machine body | 85 Kg (187,4 lb) |
| Weight standard composition | 200 Kg (441 lb) |

ON REQUEST



Inserts
Ø 75 ÷ 225 mm



Tool for flange
necks



HS rollers 250



App
"Set & Go Pro"

and:
Inserts Ø 2" ÷ 8" IPS; 3" ÷ 8" DIPS

India





DELTA 355 ALL TERRAIN

DELTA 355 ALL TERRAIN welds HDPE, PP pipes and fittings for the transportation of gas, water and other fluids under pressure from 125 mm to 355 mm (4" IPS ÷ 14" IPS). It is designed to work according to welding standard ISO 21307 High Pressure. DELTA 355 ALL TERRAIN can be equipped with two types of engine: diesel low vibration and petrol. The engine, like an electrical generator, independently gives the necessary power supply to the machine during all its working and movement phases.

Machine composition:

- Removable control panel with data-logging, memory up to 4000 welding reports, GPS traceability; USB port for welding PDF report / data download / firmware upgrade .
- Easy-life welding control system: hardware and software have been developed to interact to each other sharing data during the entire workflow. Once set the welding parameters up, the system guarantees the repetition of the welding cycles, avoiding errors. The operator only have to confirm the work phases on the just pushing a button. Possibility to pre-set 20 customized welding cycles. **Easy Life system is "Wi-Fi" ready and works together with the App "SET & GO PRO"**
- Chassis is equipped with front steering wheels and rear traction; parking brake, machine frame design for forklift lifting
- Removable machine body to work in tight spaces with shavings collection tray.
- Dragging bar designed to weld between the 3rd and 4th clamp.
- Ritmo patented insert quick release SMARTLOCK SYSTEM.
- On-board electrical milling cutter with integrated locking handle system, safety switch-off device, motor thermic protection and gas spring to easily lift/lower the facer.
- On-board heating plate with protection frame and insulated protection bag; gas-spring for easy lift/lower the heating plate
- Heating plate and facer locking system for safe transportation .
- Two hydraulic rollers for pipe loading and unloading.
- Kit for network power supply connection (upon request) excluding the machine engine and weld in closed enviroments
- 25 lt capacity tank for more than 12 working hours operating time.

STANDARD COMPOSITION



Machine body



Hydraulic
Rollers



Trolley



Control panel
with GPS



Milling cutter

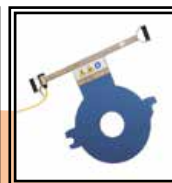

Heating plate

TECHNICAL FEATURES

PLUS

125 ÷ 355 mm
4" IPS ÷ 14" IPS

SELF CONTAINED
GPS

EASY LIFE
WELDING SYSTEM

ON REQUEST

Inserts \varnothing 125 ÷ 315 mm;
 \varnothing 4" ÷ 12" IPS;
 \varnothing 4" ÷ 12" DIPS;

Tool for flange necks,
HS 355 rollers,
Kit for for IN-DITCH use, Plug
for network power supply
connection, Lifting kit.

| | |
|-----------------------------|---|
| Working range | 125 ÷ 355 mm 4" IPS ÷ 14" IPS |
| Materials | HDPE, PP, for other materials contact RITMO S.P.A. |
| Power supply | self contained / indipendent Diesel - Kohler-Lombardini - 8,6 kW Gasoline - Honda - 14,5 kW |
| Fuel tank capacity | 25 Litres |
| Operational tank capacity | over 12 Hours |
| Absorbed power Max | 5,6 kW (230 V Single Phase) it refers to the welding machine use when connected to network power supply (excluding on-board generator) |
| Memory | 4000 Reports |
| Dimensions (W x D x H) | 2210 x 1600 x 1335 mm 83" x 63" x 52.5" |
| Weight machine body | 275 Kg (606 lb) |
| Weight standard composition | 755 Kg (1665 lb) |

DELTA 355 TRAILER

DELTA 355 TRAILER welds HDPE, PP pipes and fittings for the transportation of gas, water and other fluids under pressure from 125 mm to 355 mm (from 4" IPS to 14" IPS). **DELTA 355 TRAILER does not have an on board generator and needs external power supply; no traction.**



Delta 355 All Terrain lifting



Only machine body lifting



Gasoline or Diesel generator available



DELTA 500 TRAILER

DELTA 500 TRAILER is a self-aligning fusion machine, suitable for welding thermoplastic pipes for the transport of water, gas and other fluids under pressure, up to Ø 500 mm (6" IPS ÷ 20" IPS). Machine can fuse pipes according to the ISO 21307 High Pressure standard. Standard machine features:

- Machine body mounted on a 4 wheeled chassis, easily removable for working in tight spaces.
- New RITMO Patented assisted system to open/close/lift clamps-heater-facer.
- Machine body with an automatic heating plate detaching device: helps removing the heating plate safely and fast
- Fast-locking system which allows to place and remove inserts in seconds.
- 4 wheeled chassis with 2 steering wheels and a safety brake .
- An on-board electric facer that is equipped with a safety microswitch to prevent from accidental starts, a thermal circuit breaker to protect motor and also features an ergonomic docking system and on/off switches.
- An on-board heating plate Teflon-coated (PTFE) which comes with a high-temperature-proof bag, which also avoid the heating element from being scratched.
- Removable control panel with data-logging, memory up to 4000 welding reports, GPS traceability; USB port for welding PDF report / data download / firmware upgrade .
- Easy-life welding control system: hardware and software have been developed to interact to each other sharing data during the entire workflow. Once set the welding parameters up, the system guarantees the repetition of the welding cycles, avoiding errors. The operator only have to confirm the work phases on the just pushing a button. Possibility to pre-set 20 customized welding cycles. **Easy Life system is "Wi-Fi" ready and works together with the App "SET & GO PRO"**
- Two hydraulic rollers for pipe loading and unloading.

DELTA 500 TRAILER allows to easily weld fittings like elbows, tees, Y-branches and stub flanges. Available in 230 V single phase or three phase.

STANDARD COMPOSITION



Machine body



Hydraulic
Rollers



Trolley



Control panel
with GPS



Milling cutter

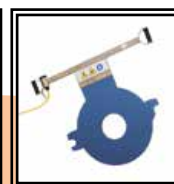

Heating plate

TECHNICAL FEATURES

PLUS

200 ÷ 500 mm

ISO 21307

HIGH PRESSURE

Assisted system
to open/close/lift
clamps-heater-facer

| | |
|-------------------------------------|---|
| Working range | 200 ÷ 500 mm; 6" IPS ÷ 20" IPS |
| Materials | HDPE, PP For other materials contact RITMO S.P.A. |
| Power supply* | 230 V Single Phase 50/60 Hz 230 V Three Phase 50/60 Hz |
| Total absorbed power | 7250 W |
| Working temperature | 180° ÷ 280° C (356° ÷ 536° F) |
| Outside temperature range | -10° ÷ 40° C (14° ÷ 104° F) |
| Dimensions machine body (W x D x H) | 1822 x 1152 x 814 mm 71.8" x 45.4" x 32" |
| Dimensions trolley (W x D x H) | 3295 x 1385 x 1331 mm 130" x 53" x 52.4" |
| Weight machine body | 580 Kg (1279 lb) |
| Weight Trolley | 270 Kg (595.3 lb) |
| Weight standard composition | 850 Kg (1830 lb) |

* Suggested power generator
12kVA



ON REQUEST



Inserts
Ø 200 ÷ 500 mm



Tool for flange
necks



HS Rollers 630



App
"Set & Go Pro"

and:
Inserts Ø 6" ÷ 18" IPS; 6" ÷ 18" DIPS; KIT for IN-DITCH USE

India



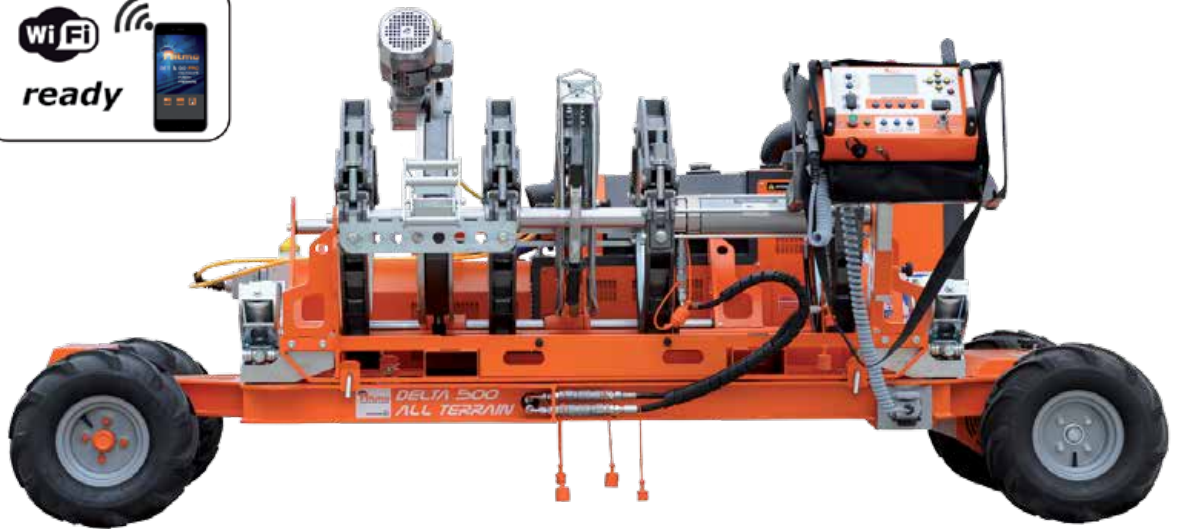

DELTA 500 ALL TERRAIN

DELTA 500 ALL TERRAIN is powered by a low-vibration diesel engine and equipped with front steering wheels and rear traction. The machine is suitable for welding pressure pipes (HDPE, PP) for the transportation of water, gas and other fluids up to Ø 500 mm (20 "IPS). Built according to the International standards ISO 21307 HIGH PRESSURE.

- Working range from Ø 200 to 500 mm (6" IPS ÷ 20" IPS).
- Welds fittings like elbows, tees, Y-branches and stub flanges.
- New RITMO Patented assisted system to open/close/lift clamps-heater-facer.
- Fast-locking system which allows to place and remove inserts in seconds.
- Intuitive control panel and large graphic display.
- Removable control panel with data-logging.
- Memory up to 4000 welding reports.
- GPS traceability.
- USB port for welding PDF report / data download / firmware upgrade
- Easy-life welding control system: hardware and software have been developed to interact to each other sharing data during the entire workflow. Once set the welding parameters up, the system guarantees the repetition of the welding cycles, avoiding errors. The operator only have to confirm the work phases on the just pushing a button. Possibility to pre-set 20 customized welding cycles.
- **Easy Life system is "Wi-Fi" ready and works together with the App "SET & GO PRO".**
- Machine body and on-board generator easily removable for working in tight spaces.
- Machine can be powered using 230 V Three phase 50/60 Hz.
- Wheeled chassis designed to be lifted using a forklift.
- Two hydraulic rollers for pipe loading and unloading.
- On-board electric facer that is equipped with a safety microswitch.
- On-board generator removable for independent use.

STANDARD COMPOSITION



Machine body



Hydraulic Rollers



Trolley



Control panel with GPS



Milling cutter

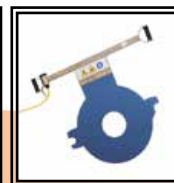

Heating plate

TECHNICAL FEATURES

PLUS

200 ÷ 500 mm

ISO 21307

HIGH PRESSURE

Assisted system
to open/close/lift
clamps-heater-facer

| | |
|-------------------------------------|--|
| Working range | 200 ÷ 500 mm; 6" IPS ÷ 20" IPS |
| Materials | HDPE, PP For other materials contact RITMO S.P.A. |
| Power supply | self contained - diesel engine 230 V Three Phase 50/60 Hz |
| Total absorbed power | 7250 W |
| Working temperature | 180° ÷ 280° C (356° ÷ 536° F) |
| Outside temperature range | -10° ÷ 40° C (14° ÷ 104° F) |
| Dimensions machine body (W x D x H) | 1822 x 1152 x 990 mm 71.7" x 45.4" x 39" |
| Dimensions trailer (W x D x H) | 2955 x 1578 x 1370 mm 116.4" x 62.1" x 54" |
| Weight standard composition | 1350 Kg (2976 lb) |



ON REQUEST



Inserts
Ø 200 ÷ 500 mm



Tool for flange
necks



Track
Conversion
System



App
"Set & Go Pro"

and:

Inserts Ø 6" ÷ 18" IPS; 6" ÷ 18" DIPS; KIT for IN-DITCH USE,
HS Roller 630; Plug for network power supply connection

Italy





DELTA 630 TRAILER

DELTA 630 TRAILER is a self-aligning fusion machine, suitable for welding thermoplastic pipes for the transport of water, gas and other fluids under pressure, up to \varnothing 630 mm. Machine can fuse pipes according to the ISO 21307 High Pressure standard.

- Machine body mounted on a 4 wheeled chassis, easily removable for working in tight spaces; steel hydraulic clamping with the fast-locking inserts, which allows to place and remove inserts in seconds; self detaching device: helps removing the heating plate during welding procedure.
- 4 wheeled chassis with 2 steering wheels and a safety brake.
- An on-board hydraulic electric facer that is equipped with a safety microswitch to prevent from accidental starts, a thermal circuit breaker to protect motor.
- An on-board hydraulic heating plate Teflon-coated (PTFE) which comes with a high-temperature-proof bag, which also avoid the heating element from being scratched.
- An EASY LIFE control panel with a large graphic display and GPS traceability, which is also removable from the machine body to be able to weld from outside the ditch. Allows the operator to program and pilot all the welding cycle in an easy, fast and very intuitive way. Includes a data-logging system to store full welding data, downloadable through a USB port. The EASY LIFE system has the capability store up to 4000 joint reports. Possibility to pre-set 20 customized welding cycles. **Easy Life system is "Wi-Fi" ready and works together with the App "SET & GO PRO"**.
- Two innovative lateral rollers that can be operated by a cordless drill.
- Control panel for hydraulic movements.

DELTA 630 TRAILER allows to easily weld fittings like elbows, tees, Y-branches and stub flanges.

STANDARD COMPOSITION



Machine body



Rollers



Hydraulic clamps



Control panel with GPS



Milling cutter



Heating plate

TECHNICAL FEATURES

PLUS

225 ÷ 630 mm
ISO 21307
HIGH PRESSURE

Steel Hydraulic
clamping

| | |
|-------------------------------------|--|
| Working range | 225* ÷ 630 mm; 8" IPS ÷ 24" DIPS |
| Materials | HDPE, PP For other materials contact RITMO S.P.A. |
| Power supply** | 230 V Three Phase 50/60 Hz 400 V Three Phase 50/60 Hz |
| Total absorbed power | 9300 W |
| Working temperature | 180° ÷ 280° C (356° ÷ 536° F) |
| Outside temperature range | -10° ÷ 40° C (14° ÷ 104° F) |
| Dimensions machine body (W x D x H) | 1822 x 1152 x 990 mm 71.7" x 53" x 39" |
| Dimensions trailer (W x D x H) | 2955 x 1578 x 1370 mm 116,3" x 62,1" x 54" |
| Weight standard composition | 1320 Kg (2910 lb) |
| Weight trolley | 435 Kg (960 lb) |

** Suggested power generator
18kVA

* 225 mm from SDR 26 to SDR 7

ON REQUEST



Inserts
Ø 225 ÷ 630 mm



Tool for flange
necks



App
"Set & Go Pro"

and:
Inserts Ø 8" ÷ 24" IPS; 8" ÷ 20" DIPS; KIT for IN-DITCH USE,
HS Roller 630, KIT hoist, metal cage for transport

India





watch the video

DELTA 630 ALL TERRAIN

DELTA 630 ALL TERRAIN is powered by a low-vibration diesel engine, suitable for welding thermoplastic pipes for the transport of water, gas and other fluids under pressure, up to \varnothing 630 mm (24" IPS"). Machine can fuse pipes according to the ISO 21307 High Pressure standard.

Standard machine features:

- Working range: \varnothing 225* - 630 mm (8" IPS - 24" DIPS); * \varnothing 225 mm from SDR 26 to SDR 7
- 4 steering wheels drive
- Diesel-engine 2200 cc 22,7 Kw
- Self-contained with on-board generator
- Sliding 3rd CLAMP for fittings welding
- Automatic welding System "Easy Life". **Easy Life system is "Wi-Fi" ready and works together with the App "SET & GO PRO".** possibility to pre-set 20 customized welding cycles
- DATA-LOGGING with GPS; memory 4000 report
- Detachable Control Panel
- Remotely wire-controlled up to 12 m
- Trench-Friendly
- SmartLock Inserts
- Hydraulic Lifts
- Hydraulic-controlled Clamps and Milling cutter
- Climbs rough terrain up to 30%

STANDARD COMPOSITION



Machine body



Hydraulic Rollers



Hydraulic clamps



Control panel with GPS



Hydraulic Milling cutter



Hydraulic Heating plate

TECHNICAL FEATURES

PLUS

225 ÷ 630 mm
4 STEERING WHEELS
DRIVE
SELF CONTAINED
WITH ON-BOARD
GENERATOR

| | |
|-------------------------------------|--|
| Working range | 225* ÷ 630 mm; 8" IPS ÷ 24" DIPS |
| Materials | HDPE, PP For other materials contact RITMO S.P.A. |
| Engine | 2200 cc - 22,7 Kw |
| Fuel type | Diesel |
| Fuel tank capacity | 40 Litres |
| Operational tank capacity | 12 Hours |
| Hydraulics reservoir capacity | 80 Litres |
| Dimensions machine body (W x D x H) | 2200 x 3100 x 2000 mm 86.6" x 122" x 78.8" |
| Weight machine body | 800 Kg (1764 lb) |
| Weight standard composition | 3000 Kg (6614 lb) |

*225 mm from SDR 26 to SDR 7

ON REQUEST



Inserts
Ø 225 ÷ 630 mm



Tool for flange
necks



App
"Set & Go Pro"

and:

Inserts Ø 8" ÷ 24" IPS; 8" ÷ 20" DIPS; KIT for IN-DITCH USE,
HS Roller 630, KIT hoist, metal cage for transport



U.S.A.





DELTA 1000 TRAILER

DELTA 1000 TRAILER is a self-aligning fusion machine, suitable for welding thermoplastic pipes for the transport of water, gas and other fluids under pressure, up to \varnothing 1000 mm. Machine can fuse pipes according to the ISO 21307 High Pressure standard.

Standard machine features:

- Machine body mounted on a 4 wheeled chassis, easily removable for working in tight spaces; steel hydraulic clamping with the fast-locking inserts, which allows to place and remove inserts in seconds; self detaching device: helps removing the heating plate during welding procedure.
- 4 wheeled chassis with 2 steering wheels and a safety brake.
- An on-board hydraulic electric facer that is equipped with a safety microswitch to prevent from accidental starts, a thermal circuit breaker to protect motor.
- An on-board hydraulic heating plate Teflon-coated (PTFE) which comes with a high-temperature-proof bag, which also avoid the heating element from being scratched.
- An EASY LIFE control panel with a large graphic display and GPS traceability, which is also removable from the machine body to be able to weld from outside the ditch. Allows the operator to program and pilot all the welding cycle in an easy, fast and very intuitive way. Includes a data-logging system to store full welding data, downloadable through a USB port. The EASY LIFE system has the capability store up to 4000 joint reports. Possibility to pre-set 20 customized welding cycles. **Easy Life system is "Wi-Fi" ready and works together with the App "SET & GO - PRO".**
- Two hydraulic lateral rollers.
- Control panel for hydraulic movements.

DELTA 1000 TRAILER allows to easily weld fittings like elbows, tees, Y-branches and stub flanges.

STANDARD COMPOSITION



Machine body



Hydraulic Rollers



Hydraulic clamps



Control panel with GPS



Hydraulic Milling cutter



Hydraulic Heating plate

TECHNICAL FEATURES

PLUS

355 ÷ 1000 mm

**HYDRAULIC
MOVEMENTS
CLAMPS, FACER
HEATER**

**Two hydraulic lateral
rollers**

* Suggested power generator
40kVA

| | |
|-------------------------------------|--|
| Working range | 355 ÷ 1000 mm; 14" IPS ÷ 36" IPS/DIPS |
| Materials | HDPE, PP For other materials contact RITMO S.P.A. |
| Power supply* | 230 V Three Phase 50/60 Hz 400 V Three Phase 50/60 Hz |
| Total absorbed power | 32000 W |
| Working temperature | 180° ÷ 280° C (356° ÷ 536° F) |
| Outside temperature range | -10° ÷ 40° C (14° ÷ 104° F) |
| Time to reach welding temperature | < 45' |
| Dimensions machine body (W x D x H) | 3890 x 2890 x 2845 mm 153.1" x 113.8" x 112" |
| Dimensions trolley (W x D) | 4450 x 2285 mm 175,2" x 90" |
| Weight machine body | 4385 Kg (9667 lb) |
| Weight Trolley | 830 Kg (1830 lb) |

ON REQUEST



Inserts
Ø355÷900 mm



Tool for flange
necks



Trolley



HS roller 630



App
"Set & Go Pro"



watch the video

and:

Inserts Ø 14" ÷ 36" IPS; 14" ÷ 36" DIPS; KIT for IN-DITCH USE , KIT hoist, pallet for transport

Israel







PLUS
LARGE GRAPHIC DISPLAY
“OPEN SYSTEM”

THE INSPECTOR

THE INSPECTOR - DATA LOGGING that controls, records and generates a PDF report of the entire welding process. The Inspector is an “open system” that can be used with Ritmo machines or others. The large graphic display allows an easy reading of welding reports.

THE INSPECTOR is installed in a hard case made of PP, with protection degree IP 67. It is sold with a bag that contains the data logging and the battery charger with international adapters.

- Preloaded Major Welding Standard (ISO, DVS, and others)
- Memory of 1000 cycles
- USB port for Welding Report in PDF
- Integrated GPS
- Firmware upgradable via USB
- Battery operated (24 hr of operational work)
- Battery charger with international adapters
- Built-in plastic case in PP with IP67 protection class
- Transport bag
- Applicable to Ritmo machines and other

POWER SUPPLY 24 V DC
 Outside Temperature Range -10° C 40° C (14° ÷ 104° F)
 Protection Degree IP 67
 Dimensions Data Logging 240 x 265 x 110 mm (9.4” x 10.4” x 4.3”)
 Weight 2,6 Kg (5,7 lb)

STANDARD COMPOSITION

THE INSPECTOR, transport bag, battery, charger and International adapters

ON REQUEST

Transducer connection cables; the cable and the transducer may vary according to the welder model (see price list for the correspondent codes)
 Infrared thermometer

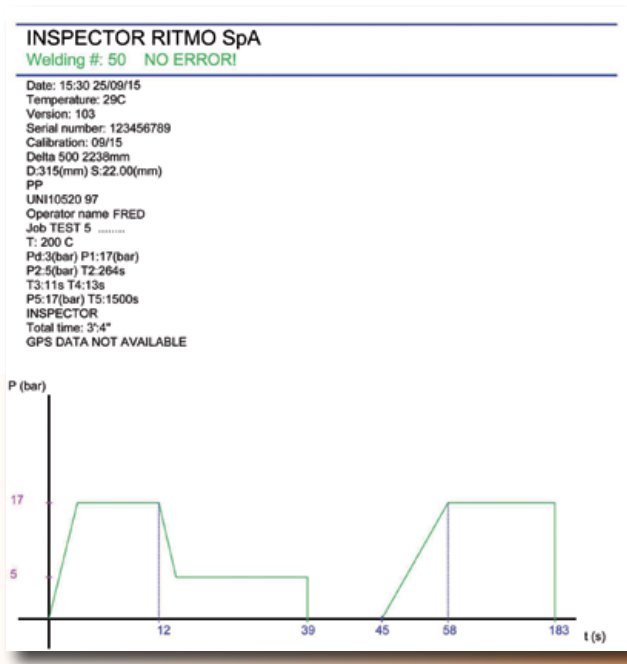

PLUS

INTUITIVE
EASY TO USE
ACCURATE
VERSATILE

COMPOSED OF FEW
PARTS



RID - RITMO INTERNAL DEBEADER

Internal Debeader by RITMO S.p.A. covering a range from \varnothing 90 up to 630 mm (3" ÷ 24 IPS).
A complete kit set is composed by:

- 6 pcs of alloy rods 2,15 mtr (84.6") each (one is acting as turn handle)
- 5 pcs of center rings to ensure that the rods are in center of the pipe.
- Alloy rods are delivered in a special carrying bag with a handle
- Internal Debeader Head 90 - 110 mm (* 3" IPS)
- Internal Debeader Head 125 - 160 mm (* 4" ÷ 5" IPS)
- Internal Debeader Head 160 - 200 mm (* 5" ÷ 6" IPS)
- Internal Debeader Head 225 - 315 mm (* 8" ÷ 10" IPS)
- Internal Debeader Head 355 - 500 mm (* 12" ÷ 18" IPS)

Sold separately:

- Internal Debeader Head 560 - 630 mm (* 22" ÷ 24" IPS)



watch the video



TECHNICAL FEATURES

| Models | Max Bead width |
|---|---|
| \varnothing 90 ÷ 110 mm; 3" IPS ÷ 3" DIPS | 20 mm |
| \varnothing 125 ÷ 160 mm; 4" ÷ 5" IPS | 25 mm |
| \varnothing 160 ÷ 200 mm; 5" ÷ 6" IPS | 25 mm |
| \varnothing 225 ÷ 315 mm; 8" ÷ 10" IPS | 35 mm |
| \varnothing 355 ÷ 500 mm; 12" ÷ 18" IPS | 35 mm |
| \varnothing 560 ÷ 630 mm; 22" ÷ 24" IPS | 45 mm |
| Materials | HDPE, PP, PP-R, PVDF For other materials contact RITMO S.P.A. |

*Contact us or your distributor for reference chart of SDR covered

PLUS

INTUITIVE
EASY TO USE
ACCURATE
VERSATILE

FOR PIPES
UP TO 1200 mm
AND SHEETS



RED - RITMO EXTERNAL DEBEADER

External Debeader by RITMO S.p.A. covering a range from \varnothing 63 up to 1200 mm; 2" IPS ÷ 48" IPS

Designed to remove the external bead from a complete butt fusion welded joint. The tool knocks onto the pipe bead, then alignment blocks slide against the pipe surface to guide it around the pipe. The blade cuts the under the bead and the handle helps pull the tool around the pipe, cutting the bead away. RED works on flat surfaces too and removes the bead from plastic sheets without the guides for pipes.

Available in three different sizes

- RED 63 - 125
- RED 90 - 400
- RED 400 - 1200

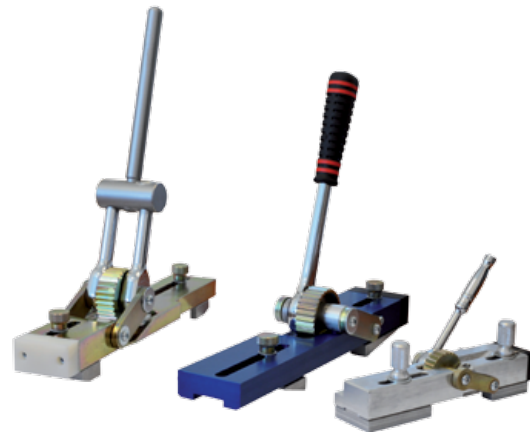

TECHNICAL FEATURES

| Models | Working range |
|----------------|--|
| RED 63 - 125 | \varnothing 63 ÷ 125 mm; 2" IPS ÷ 4" IPS |
| RED 90 - 400 | \varnothing 90 ÷ 400 mm; 3" IPS ÷ 14" DIPS |
| RED 400 - 1200 | \varnothing 400 ÷ 1200 mm; 16" IPS ÷ 48" IPS |
| Material | HDPE |



ROLLERS 355

ROLLERS

This device is essential for supporting the pipes while they are being welded with the butt fusion machines. The roller minimizes pipe friction and drag force independently of the jobsite conditions.

- ROLLER 355 can sustain pipes up to \varnothing 355 mm - 14" IPS. Easy to use and light

- ROLLER 1000 can sustain pipes from up to 1000 mm - 36" DIPS. The structure is light, so it is easy to carry and can be disassembled and reassembled in a few steps. This feature allows to store up to eight rollers in a single pallet thus improving transportation and logistics. Another advantage is the misalignment of the rollers in order to move the pipe easily even with the presence of weld beads. Working range from \varnothing 315 to 1000 mm (10" DISP - 36" DIPS).

STANDARD COMPOSITION

Complete roller with tools

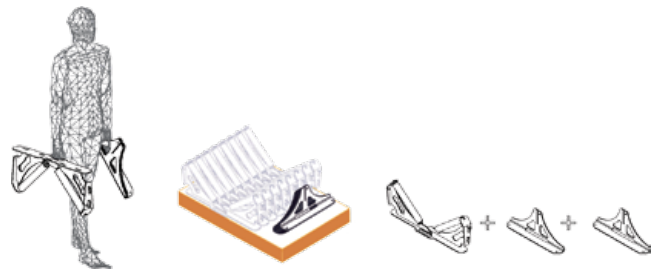

TECHNICAL FEATURES

| | |
|---------------------|--|
| Rollers 355 | |
| Working range | \varnothing 0 ÷ 355 mm; up to 14" IPS |
| Dimensions | 360 x 220 x 200 mm 14.1" x 8.6" x 7.9" |
| Weight | 6 Kg (13.2 lb) |
| Rollers 1000 | |
| Working range | \varnothing 315 ÷ 1000 mm \varnothing 10" DIPS ÷ 36" DISP |
| Dimensions | 1040 x 600 x 320 mm 41" x 23.6" x 12.6" |
| Weight | 27 Kg (59.5 lb) |



ROLLERS 1000



HS ROLLERS

HIGH STAND ROLLERS, this device is essential for supporting the pipes while they are being welded with the butt fusion machines. The rollers minimise pipe friction and drag force no matter which is the construction site condition. Special design for All Terrain / Trailer Line.

HS ROLLERS 250

Working range max: \varnothing 250 mm (8" DIPS)
 Overall dimension (W x D x H):
 1150 x 500 x 756 mm
 45.3" x 19.7" x 29.7"
 Weight: 26 Kg 57.3 lb
 Weight capacity: 500 Kg 1.100 lb



HS - ROLLERS 250

HS ROLLERS 355

Working range max: \varnothing 355 mm (14" IPS)
 Overall dimension (W x D x H):
 1421 x 600 x 818 mm
 55.9" x 23.6" x 32.2"
 Weight: 33 Kg 72.8 lb
 Weight capacity: 1000 Kg 2.200 lb



HS - ROLLERS 355

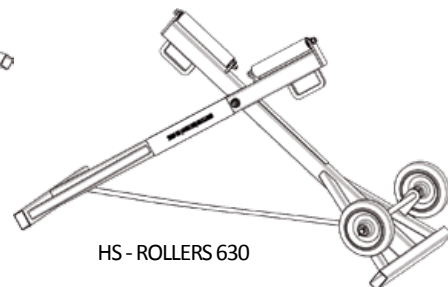

HS - ROLLERS 630

HS ROLLERS 630

Working range max: \varnothing 630 mm (24" DIPS)
 Overall dimension (W x D x H):
 1766 x 800 x 982 mm
 69.5" x 31.5" x 38.6"
 Weight: 55 Kg 121.2 lb
 Weight capacity: 2000 Kg 4.400 lb

HS ROLLERS 1000

Working range max: \varnothing 1000 mm (36" DIPS)
 Weight: 140 Kg 309 lb
 Weight capacity: 3000 Kg 6.600 lb

HS - ROLLERS 1000



ELECTROFUSION BY RITMO:



- High performance
- Barcode reading system
- Easy to use
- 90° universal adapter Ø 4,0 - 4,7 mm
- Laser scanner
- Usb port
- PDF report
- Large memory
- Graphic display multilingual
- Intuitive control panel
- Traceability

ELECTROFUSION MACHINES



WORKING RANGE Ø mm

| HIGH PRESSURE | 20 | 25 | 32 | 40 | 50 | 63 | 75 | 90 | 110 | 125 | 140 | 160 | 180 | 200 | 225 | 250 | 280 | 315 | 355 | 400 | 450 | 500 | 560 | 630 | 710 | 800 | 900 | 1000 | > 1000 |
|---------------|----|----|----|----|----|----|----|----|-----|-----|-----|-----|-----|-----|-----|-----|-----|-----|-----|-----|-----|-----|-----|-----|-----|-----|-----|------|--------|
| ELEKTRA LIGHT | 20 | 25 | 32 | 40 | 50 | 63 | 75 | 90 | 110 | 125 | 140 | 160 | | | | | | | | | | | | | | | | | |
| ELEKTRA 315 | 20 | 25 | 32 | 40 | 50 | 63 | 75 | 90 | 110 | 125 | 140 | 160 | 180 | 200 | 225 | 250 | 280 | 315 | | | | | | | | | | | |
| ELEKTRA 500 | 20 | 25 | 32 | 40 | 50 | 63 | 75 | 90 | 110 | 125 | 140 | 160 | 180 | 200 | 225 | 250 | 280 | 315 | 355 | 400 | 450 | 500 | | | | | | | |
| ELEKTRA 1000 | 20 | 25 | 32 | 40 | 50 | 63 | 75 | 90 | 110 | 125 | 140 | 160 | 180 | 200 | 225 | 250 | 280 | 315 | 355 | 400 | 450 | 500 | 560 | 630 | 710 | 800 | 900 | 1000 | > 1000 |
| ELEKTRA TOP | 20 | 25 | 32 | 40 | 50 | 63 | 75 | 90 | 110 | 125 | 140 | 160 | 180 | 200 | 225 | 250 | 280 | 315 | 355 | 400 | 450 | 500 | 560 | 630 | 710 | 800 | 900 | 1000 | > 1000 |

| LOW PRESSURE | 20 | 25 | 32 | 40 | 50 | 63 | 75 | 90 | 110 | 125 | 140 | 160 | 180 | 200 | 225 | 250 | 280 | 315 |
|------------------|----|----|----|----|----|----|----|----|-----|-----|-----|-----|-----|-----|-----|-----|-----|-----|
| MUSTANG 160 V1 | | | 32 | 40 | 50 | 63 | 75 | 90 | 110 | 125 | 140 | 160 | | | | | | |
| UNIVERSAL 160 V1 | | | 32 | 40 | 50 | 63 | 75 | 90 | 110 | 125 | 140 | 160 | 180 | 200 | 225 | 250 | 280 | 315 |



ELEKTRA LIGHT

ELEKTRA LIGHT is an universal electrofusion machine, suitable for welding pipe/fittings for the transport of gas, water and for welding fire sprinkler system (HDPE, PP, PP-R couplings from 8 to 48 V). The Elektra Light machine is made in compliance with international standards. This welding machine's structure is light weight, so it is extremely easy to carry around. Composed of: machine body, an in built memory with 325 welding cycles, featuring the possibility of transferring data to a Pc/Laptop, report in PDF file.

STANDARD COMPOSITION



Universal connectors 90°

Laser scanner

Manual scraper

ON REQUEST



Software Ritmo Transfer

Adapter DB9M-USB

* Working range might vary according to fittings brand. Check with the fitting manufacturer the power and the welding time required.

** Power at 60% Duty Cycle



TECHNICAL FEATURES

| | |
|--|--|
| Working range* | 20 ÷ 125/160 mm; ½" IPS ÷ 4"/6" IPS |
| Materials | HDPE, PP, PP-R |
| Power supply | 110 V Single Phase 50/60 Hz 230 V Single Phase 50/60 Hz |
| Absorbed power** | 1300 W |
| Max. output current | 60 A |
| 60% Duty Cycle output | 23 A |
| Memory capacity | 325 report |
| Protection degree | IP 54 |
| Weight machine body | ~ 7 Kg (15.4 lb) |
| Dimensions machine body | 200 x 250 x 210 mm; 7.9" x 9.8" x 8.3" |
| Languages | 19 |
| Suggested power generator for full welding range | 3,5 ÷ 4 kVA |



ELEKTRA 315

ELEKTRA 315 is an universal electrofusion machine, suitable for welding pipe/fittings for the transport of gas, water and for welding fire sprinkler system (HDPE, PP, PP-R couplings from 8 to 48 V). The Elektra 315 machine is made in compliance with international standards. Composed of: machine body and carrying case, intuitive control panel an in built memory with 500 welding cycles, featuring the possibility of transferring data to a Pc/Laptop; an laser scanner - barcode reading system that allows the automatic setting of the welding parameters. Report in PDF file.

STANDARD COMPOSITION



Universal connectors 90°

Laser scanner

Manual scraper

ON REQUEST



Software Ritmo Transfer

Adapter DB9M-USB

* working range might vary according to fittings brand. Check with the fitting manufacturer the power and the welding time required.

** Power at 60% Duty Cycle

TECHNICAL FEATURES



| | |
|--|--|
| Working range* | 20 ÷ 315 mm; ½" IPS ÷ 10" DIPS |
| Materials | HDPE, PP, PP-R |
| Power supply | 110 V Single Phase 50/60 Hz 230 V Single Phase 50/60 Hz |
| Absorbed power** | 2600 W |
| Max. output current | 100 A |
| 60% Duty Cycle output | 60 A |
| Memory capacity | 500 report |
| Protection degree | IP 54 |
| Weight machine body | ~ 16 Kg (35.2 lb) |
| Dimensions machine body | 263 x 240 x 300 mm; 10.3" x 9.4" x 1.8" |
| Dimensions transport case | 405 x 285 x 340 mm; 16" x 11.2" x 13.4" |
| Languages | 21 |
| Suggested power generator for full welding range | 5,5 ÷ 6 kVA |



ELEKTRA 500 - ELEKTRA 1000

ELEKTRA is an high performance universal electrofusion machine, suitable for welding HDPE, PP, PP-R couplings (from 8 to 48 V). It is available in two versions: ELEKTRA 500, ELEKTRA 1000, and are composed of:

- machine body surrounded by a tubular steel frame, thus creating a protective structure that gives to the welding design and functionality while also serving as transport handle and cable winding
- large graphic display that stands out for the size and resolution of the icons, making them easy to read in the setting and welding stages
- intuitive control panel that simplifies and speeds up the setting of the welder
- Universal connectors 90° 4 - 4,7 mm; no need of adapters
- Laser scanner - barcode reading system that allows the welding parameters automatic setting. Possibility to set the welding parameters manually: by setting the welding tension/time, or by entering the fitting's numerical code indicated under the bar code. Traceability function ISO 12176
- internal memory of 4000 welds; the name of the operator among with the traditional welding data can be generated in PDF format. These reports can be downloaded to a PC through a USB port
- the USB port allows updating the welder firmware, the reports download or a printer ESC-POS connection
- GPS (on request)

STANDARD COMPOSITION



Universal connectors 90°



Laser scanner



Manual scraper



Transport case

Models available:

ELEKTRA 500
230 V CE or Schuko socket
ELEKTRA 1000
230 V CE or Schuko socket.

ELEKTRA 500 GPS 110 V or 230 V
ELEKTRA 1000 GPS 230 V

TECHNICAL FEATURES

PLUS

**HIGH
PERFORMANCE**

REPORT PDF

DISPLAY 6,5"

| Model | ELEKTRA 500 | ELEKTRA 1000 |
|---|--|---|
| Working range* | 20 ÷ 500 mm ½" IPS ÷ 20" IPS | 20 ÷ 1600 mm ½" IPS - 63" IPS |
| Materials | HDPE, PP, PP-R | HDPE, PP, PP-R |
| Welding output voltage | 8 ÷ 48 V | 8 ÷ 48 V |
| Power supply | 110 V Single Phase 50/60 Hz 230 V Single Phase 50/60 Hz | 230 V Single Phase 50/60 Hz |
| Absorbed power** | 3100 W (110 V) 3100 W (230 V) | 3500 W |
| Max. output current | 100 A (110 V) 120 A (230 V) | 120 A |
| 60% Duty Cycle output | 70 A | 90 A |
| Operating mode | Barcode Manual (Numerical code or tension/time) | Barcode Manual (Numerical code or tension/time) |
| Connections | USB for external memory and ESC-POS | USB for external memory and ESC-POS |
| Memory | 4000 Reports | 4000 Reports |
| Outside temperature range | -20° ÷ 50° C; (-4° ÷ 122° F) | -20° ÷ 50° C (-4° ÷ 122° F) |
| T° reading probe precision | ± 1° C (± 33,8° F) | ± 1° C (± 33,8° F) |
| Traceability data | ISO 12176 | ISO 12176 |
| Protection degree | IP 54 | IP 54 |
| Languages | 19 | 19 |
| Dimensions machine body | 255 x 270 x 385 mm 10" x 10.6" x 15.1" | 255 x 270 x 385 mm 10" x 10.6" x 15.1" |
| Dimensions transport case | 410 x 290 x 485 mm 16.1" x 11.4" x 19.1" | 410 x 290 x 485 mm 16.1" x 11.4" x 19.1" |
| Weight with cables | ~ 18 Kg (39.6 lb) | ~ 20 Kg (44.1 lb) |
| Suggested power genera- tor for full welding range | 5,5 ÷ 6 kVA | 6,5 ÷ 7 kVA |

* Working range might vary according to fittings brand. Check with the fitting manufacturer the power and the welding time required.

** Power at 60% Duty Cycle



watch the video

Italy





ELEKTRA TOP

ELEKTRA TOP is a high performance universal electrofusion machine, characterized by its light weight and high efficiency. The machine is suitable to weld HDPE, PP, PP-R couplings and has an approximate diameter working range* up to 1600 mm. (½" IPS - 63" IPS) . Elektra TOP (230 V) is available in two version: for couplings 8 ÷ 48 V and couplings 8 ÷ 80 V

- Steel machine frame containing the newest Ritmo's electrofusion technology. Safe transportation thanks to Elektra Top's wide handle which enables a perfect grip and cable winding.
- 4000 welding reports memory.
- Welding reports can be downloaded directly in PDF file format, CSV, or BIN (Software Ritmo Transfer required) in to an external pen drive through the machine usb port, which allows also the welder firmware updating, or a printer ESC-POS connection.
- Large graphic display 6,5" LCD.
- Intuitive control panel.
- Universal connectors 90° Ø 4 - 4,7 mm; no need of adapters.
- Laser scanner - barcode reading system that allows the welding parameters automatic setting. Possibility to set the welding parameters manually: by setting the welding tension/time, or by entering the fitting's numerical code indicated under the bar code. Traceability function ISO 12176.
- GPS (on request).

Elektra TOP is available in 110 V or 230 V.

Elektra TOP 110 V has approximate diameter working range* Ø 20 ÷ 500 mm (½" IPS ÷ 20" IPS)

STANDARD COMPOSITION



Universal connectors 90°



Laser Scanner



Manual scraper



Steel transport case

ON REQUEST



Software Ritmo Transfer

PLUS

**LIGHT
WEIGHT**

**HIGH
PERFORMANCE**

DISPLAY 6,5"



* Working range might vary according to fittings brand. Check with the fitting manufacturer the power and the welding time required.

** Elektra Top (230 V) is available in two version:
for couplings 8 ÷ 48 V and couplings 8 ÷ 80 V

*** Power at 60% Duty Cycle

TECHNICAL FEATURES

| | |
|--|---|
| Working range * | 20 ÷ 1600 mm ½" IPS - 63" DIPS |
| Materials | PE, PP, PP-R |
| Welding output voltage** | 8 ÷ 48 V 8 ÷ 80 V |
| Power supply | 190 ÷ 265 V Single phase |
| Frequency | 40 ÷ 70 Hz |
| Absorbed power *** | 3500 W |
| Nominal Current | 15 A |
| Max. output current | 120 A |
| Operating mode | Barcode Manual (Numerical codes / tension / time) |
| Connection USB | report PDF / data download firmware upgrade print ESC-POS |
| Memory | 4000 cycles |
| Report file format | PDF, CSV, BIN |
| Working Temperature | -20° ÷ 50° C (-4° ÷ 122° F) |
| T° reading probe precision | ± 1° C |
| Protection degree | IP 54 |
| Connectors | 90° Universal 4 - 4.7 mm |
| Display | 6,5" LCD |
| Dimensions welding machine | 259 x 342 x 428 mm 10.3" x 13.5" x 16.8" |
| Dimensions transport case | 480 x 350 x 400 mm 18.9" x 13.8" x 15.7" |
| Weight with cables | ~ 13,9 Kg (26 lb) |
| Languages | 19 |
| Traceability data | ISO 12176 |
| Suggested power generator for full welding range | 7 kVA |

Available in 110 V

Max. absorbed power *** 3100 W

Indicative working range * Ø 20 ÷ 500 mm; 1/2" IPS ÷ 20" IPS



ELEKTRA LINE - OVERVIEW

| | ELEKTRA LIGHT | ELEKTRA 315 | ELEKTRA 500 | ELEKTRA 1000 | ELEKTRA TOP |
|--|---|---|---|---|---|
| Working range* | 20 ÷ 125/160* ½" IPS ÷ 6" IPS* | 20 ÷ 315* ½" IPS ÷ 10" DIPS* | 20 ÷ 500* ½" IPS ÷ 20" IPS* | 20 ÷ 1600* ½" IPS - 63" IPS* | 20 ÷ 1600* ½" IPS - 63" IPS* 20 ÷ 500 (110 V)* ½" IPS ÷ 20" IPS* |
| GPS | - | - | on request | on request | on request |
| Automatic Temperature compensation | √ | √ | √ | √ | √ |
| Constantly welding cycle monitored | √ | √ | √ | √ | √ |
| Barcode scanner (ISO 13950) | √ | √ | √ | √ | √ |
| Manual fusion input | √ | √ | √ | √ | √ |
| Welding report | √ | √ | √ | √ | √ |
| Connections | Adapter DB9M-USB | Adapter DB9M-USB | USB port Type A | USB port Type A | USB port Type A |
| Report file format | PDF - BIN | PDF - BIN | PDF - BIN - CSV | PDF - BIN - CSV | PDF - BIN - CSV |
| Memory | 325 cycles | 500 cycles | 4000 cycles | 4000 cycles | 4000 cycles |
| Sound allarm | √ | √ | √ | √ | √ |
| Error recognition | √ | √ | √ | √ | √ |
| Fusion time | √ | √ | √ | √ | √ |
| Cooling time | √ | √ | √ | √ | √ |
| Connectors | 90° universal adapters 4.00 - 4,7 mm | 90° universal adapters 4.00 - 4,7 mm | 90° universal adapters 4.00 - 4,7 mm | 90° universal adapters 4.00 - 4,7 mm | 90° universal adapters 4.00 - 4,7 mm |
| Outside Temperature range | -10° ÷ 50° C (-14° ÷ 122° F) | -10° ÷ 50° C (-14° ÷ 122° F) | -20° ÷ 50° C (-4° ÷ 122° F) | -20° ÷ 50° C (-4° ÷ 122° F) | -20° ÷ 50° C (-4° ÷ 122° F) |
| Power supply (Vac) | 110 V or 230 V | 110 V or 230 V | 110 V or 230 V | 230 V | 110 V or 230 V |
| Frequency | 50/60 Hz | 50/60 Hz | 50/60 Hz | 50/60 Hz | 50/60 Hz |
| Max output current | 60 A | 100 A | 100 A (110 V) 120 A (230 V) | 120 A | 100 A (110 V) 120 A (230 V) |
| Welding output voltage | 8 ÷ 48 V | 8 ÷ 48 V | 8 ÷ 48 V | 8 ÷ 48 V | 8 ÷ 48 V *** 8 ÷ 80 V *** |
| Absorbed power ** | 1300 W** | 2600 W (110 V) ** 2600 W (230 V)** | 3100 W (110 V) ** 3100 W (230 V) ** | 3500 W ** | 3100 W (110 V) ** 3500 W (230 V) ** |
| Suggested power generator for full welding range | 3,5 ÷ 4 kVA | 5,5 ÷ 6 kVA | 5,5 ÷ 6 kVA | 6,5 ÷ 7 kVA | 7 kVA |
| Protection degree | IP 54 | IP 54 | IP 54 | IP 54 | IP 54 |
| Electrical fuse protection | √ | √ | √ | √ | √ |
| Display | Single line LCD | Graphic LCD 2,4" | Graphic LCD 6,5" | Graphic LCD 6,5" | Graphic LCD 6,5" |
| Machine body dimensions | 200x250x210mm 7.9" x 9.8" x 8.3" | 263 x 240 x 300 mm 10.3" x 9.4" x 1.8" | 255 x 270 x 385 mm 10" x 10.6" x 15.1" | 255 x 270 x 385 mm 10" x 10.6" x 15.1" | 259 x 342 x 428 mm 10.3" x 13.5" x 16.8" |
| Carrying case dimensions | - | 405 x 285 x 340 mm 16" x 11.2" x 13.4" | 410 x 290 x 485 mm 16.1" x 11.4" x 19.1" | 410 x 290 x 485 mm 16.1" x 11.4" x 19.1" | 390 x 350 x 500 mm 15.3" x 13.8" x 19.7" |
| Weight machine + cables | ~ 7 Kg | ~ 16 Kg (35.3 lb) | ~ 18 Kg (39.6 lb) | ~ 20 Kg (44 lb) | ~ 13,9 Kg (30.6 lb) |
| Weight carrying case | - | 3.9 Kg (8.6 lb) | 4.8 Kg (10.5 lb) | 4.8 Kg (10.5 lb) | 6,6 Kg (14.55 lb) |
| Traceability | - | Fitting | Pipe/Fitting/Pipe | Pipe/Fitting/Pipe | Pipe/Fitting/Pipe |

* Working range might vary according to fittings brand. Check with the fitting manufacturer the power and the welding time required.

** Power at 60% Duty Cycle

*** Elektra TOP (230 V) is available in two version: for couplings 8 ÷ 48 V and couplings 8 ÷ 80 V

MUSTANG 160 V1

This electrofusion machine is suitable for welding electrofusion fittings in HDPE from \varnothing 32 to \varnothing 160 mm (1" IPS ÷ 5" IPS), for low-pressure conduits. The MUSTANG 160 V1 automatically detects connection to the fitting to be welded and compensates current supplied according to ambient temperature. It is also capable of detecting any malfunction that could occur before or during welding procedures. MUSTANG 160 V1 is made in compliance with the current safety standards and Directives, and the structure is light weight which makes it extremely easy to carry around.

SUPPLIED WITH

- Welding machine complete with cables with pins, transport case and manual scraper.



TECHNICAL FEATURES

| | |
|-----------------------------|--|
| Working range | 32 ÷ 160 mm; 1" IPS ÷ 5" IPS |
| Materials | HDPE |
| Power supply | 230 V Single Phase 50/60 Hz 110 V Single Phase 50/60 Hz |
| Max. absorbed power | 1000 W |
| Max. output current | 5 A (230 V); 9 A (110 V) |
| Outside temperature range | - 5° ÷ 40° C (23° ÷ 104° F) |
| Ambient temperature probe | Electronic |
| Protection degree | IP 54 |
| Weight machine body * | 2,6 Kg (5.7 lb) |
| Weight with carrying case * | 5,3 Kg (11.6 lb) |
| Dimensions machine body * | 180 x 230 x 75 mm; 7.1" x 9" x 3" |
| Dimensions carrying case * | 220 x 450 x 180 mm; 8.7" x 17.7" x 7.1" |

* mod. 230 V

UNIVERSAL 315 V1

Electrofusion welding machine:

PP-R from \varnothing 20 mm** (optional cables)

- Graphic display
- Auto recognition of fittings
- Memory with 350 welding reports
- Report in PDF File
- Serial/USB connector (optional)
- Self-compensation of the current supplied (according to the ambient temperature)
- Transport case
- Firmware upgradable via USB

STANDARD COMPOSITION

- carrying suitcase
- welding cables (A00, A00+, A01, A02, A04)
- welding extension cable
- manual scraper
- shoulder belt

ON REQUEST

- serial/USB adapter (welding data transfer)
- welding cable (A05)
- Printer

** WELDING CABLES

A00 32 ÷ 160 mm (1" IPS ÷ 5" IPS)
Coes, Akatherm, Eurofusion, Geberit, Valsir, Wavin Vulcathene

A00+ 200 ÷ 315mm (6" DIPS ÷ 10" DIPS) Wavin (Waviduo)

A01 200 ÷ 315mm (6" DIPS ÷ 10" DIPS)
Akatherm, Valsir, Eurofusion

A02 200 ÷ 315mm (6" DIPS ÷ 10" DIPS) Geberit

A04 200 ÷ 315mm (6" DIPS ÷ 10" DIPS) Coes (Coestilen)

OPTIONAL CABLE

A05 20 ÷ 63mm (½" IPS ÷ 2" IPS)
(PP-R) Coes (Coestherm - not 8÷48 V)



mod. 230 V

mod. 110 V

TECHNICAL FEATURES

| | |
|---------------------------|--|
| Working range | 20** ÷ 315 mm; ½" IPS ÷ 10" DIPS |
| Power supply | 230 V Single Phase 50/60 Hz 110 V Single Phase 50/60 Hz |
| Max. absorbed power | 2470 W (230 V) 2700 (110 V) |
| Outside temperature range | -10° ÷ 45° C (14° ÷ 113° F) |
| Temperature compensation | Automatic Electronic |
| Protection degree | IP 54 |
| Weight machine body | 3,4 Kg (7.5 lb) (230 V) 19 Kg (41.8 lb) (110 V) |
| Weight with carrying case | 7,2 Kg (15.9 lb) |
| Dimensions machine body | 255x180x110 mm; 10" x 7.1" x 4.3" (230 V) 330x270x220 mm; 13" x 10.6" x 8.6" (110 V) |
| Dimensions carrying case | 220x450x180 mm; 8.7" x 17.7" x 7.1" (230 V) 410x290x485 mm; 16.1" x 11.4" x 19.1" (110 V) |

PIPE CUTTERS

These are professional tools, essential for the manual cut of plastic pipes up to Ø 315 mm (10" DIPS). The TC 108, T1, TU 75, TU 140, T3 and T4 pipe cutters are made with the very best alloys, and are very manageable and practical to use. The pipe cutters can be fitted with various special blades with appropriate cutting heights and penetration capacities to cut pipes of different materials. The TC 108 and T1 pipe cutters (with special blades) can cut Copper (Cu) and multilayer (PEX/Al, PPR/Al, etc.) pipes.

STANDARD COMPOSITION

- Pipe cutter with blade:

TC 108

T 1 + blade Ø 25 mm (1")

TU 75 + blade Ø 44 mm (1.7")

TU 140 + blade Ø 53 mm (2.1")

T 3 + blade Ø 53 mm (2.1")

T 4 + blade Ø 53 mm (2.1")

(HDPE 80 - HDPE 100: Ø 250 SDR 13>; Ø 315 SDR 17,5>)

- Carrying case (for the T4 pipe cutter, only)

ON REQUEST

- Blades of different diameters and heights

TECHNICAL FEATURES

| MODEL | Working range Ø | Thickness | Overall dimensions | Weight |
|--------|------------------------------------|---------------|---|------------------|
| TC 108 | 6 ÷ 50 mm ½" CTS ÷ 1½" IPS | up to 4,2 mm | 178 x 228 x 65 mm 7" x 9" x 2,5" | 0,38 Kg (0.8 lb) |
| T1 | 6 ÷ 64 mm ½" CTS ÷ 2" IPS | up to 5,5 mm | 222 x 282 x 95 mm 8.7" x 11.1" x 3.7" | 0,60 Kg (1.3 lb) |
| TU 75 | 6 ÷ 76 mm ½" CTS ÷ 2" IPS | up to 11,5 mm | 247 x 330 x 105 mm 9.7" x 13" x 4.1" | 0,68 Kg (1.5 lb) |
| TU 140 | 50 ÷ 140 mm 2" IPS ÷ 5" IPS | up to 17,5 mm | 351 x 483 x 155 mm 18.8" x 19" x 6.1" | 1,38 Kg (3 lb) |
| T3 | 100 ÷ 160 mm 3" DIPS ÷ 5" IPS | up to 17,5 mm | 372 x 465 x 200 mm 14.6" x 18.3" x 7.9" | 1,65 Kg (3.6 lb) |
| T4 | 180 ÷ 315 mm 6" DIPS ÷ 10" DIPS | up to 19,4 mm | 670 x 880 x 360 mm 26.4" x 34.6" x 14.2" | 7 Kg (15.4 lb) |

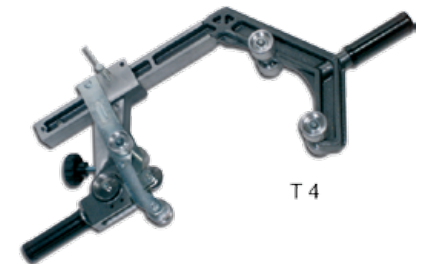

SHEARS

These are professional tools, essential for the manual cut of plastic pipes, such as PP and PP-R up to PN 25; HDPE, PB and PVDF up to Ø 75 mm (2" IPS). The C3 AC shears is entirely made in steel.

SUPPLIED WITH

- Shear body with blade

ON REQUEST

- Plastic case for C 42



C 42



C2 AC



C3 AC

TECHNICAL FEATURES

| MATERIALS | HDPE, PP, PP-R, PB, PVDF | | |
|-----------|--------------------------|--|------------------|
| MODEL | Working range Ø | Overall dimensions | Weight |
| C 42 | up to 42 mm 1 ¼" IPS | 110 x 27 x 225 mm 4.3" x 1" x 8.9" | 0,35 Kg (0.8 lb) |
| C2 AC | up to 42 mm 1 ¼" IPS | 120 x 25 x 225 mm 4.7" x 1" x 8.9" | 0,5 Kg (1.1 lb) |
| C3 AC | up to 75 mm 2" IPS | 170 x 35 x 520 mm 6.7" x 1.4" x 20,5" | 2,7 Kg (6 lb) |



original

step 1 - facing

step 2 - scraping



watch the video

TURBO 20 - 63

TURBO is the pipe scraper patented by RITMO for pipes and fittings ranging from \varnothing 20 to 63 mm SDR 6 to 11 and from $\frac{1}{2}$ " CTS to 2" IPS". TURBO is simple and easy to use. This incredible pipe scraper can work in confined spaces substantially reducing working times, especially during repair operations. The rotating tool allows fast and precise scraping, without defects. Its blades also allow the perfect facing of the pipe ends which have been roughly cut due to a situation which makes the use of a pipe cutter difficult, like narrow spaces.

Fifteen different sizes of the TURBO are available, according to the pipe size (metric or inch). TURBO has to be used with a cordless drill.

TECHNICAL FEATURES



| METRIC MODEL | Working range | Min ÷ Max Thickness | Scraping Length | Weight |
|--------------|---------------------|---------------------|-----------------|---------|
| TURBO 20 | \varnothing 20 mm | 2,3 ÷ 3,8 mm | 45 mm | 0,37 Kg |
| TURBO 25 | \varnothing 25 mm | 2,3 ÷ 5,3 mm | 45 mm | 0,47 Kg |
| TURBO 32 | \varnothing 32 mm | 2,3 ÷ 6,8 mm | 45 mm | 0,64 Kg |
| TURBO 40 | \varnothing 40 mm | 2,3 ÷ 8,3 mm | 55 mm | 0,82 Kg |
| TURBO 50 | \varnothing 50 mm | 2,3 ÷ 10,3 mm | 55 mm | 1,02 Kg |
| TURBO 63 | \varnothing 63 mm | 2,3 ÷ 13,3 mm | 55 mm | 1,29 Kg |

| INCH MODEL | Working range | Min ÷ Max Thickness | SCRAPING LENGTH |
|-----------------------------|-------------------------------------|---------------------|-----------------|
| TURBO $\frac{1}{2}$ " CTS | \varnothing $\frac{1}{2}$ " CTS | 0.06" ÷ 0.09" | 1.77" |
| TURBO $\frac{3}{4}$ " CTS | \varnothing $\frac{3}{4}$ " CTS | 0.064" ÷ 0.146" | 1.77" |
| TURBO 1" CTS | \varnothing 1" CTS | 0.08" ÷ 0.188" | 1.77" |
| TURBO $\frac{1}{2}$ " IPS | \varnothing $\frac{1}{2}$ " IPS | 0.09" ÷ 0.17" | 1.77" |
| TURBO $\frac{3}{4}$ " IPS | \varnothing $\frac{3}{4}$ " IPS | 0.09" ÷ 0.20" | 1.77" |
| TURBO 1" IPS | \varnothing 1" IPS | 0.09" ÷ 0.26" | 1.77" |
| TURBO 1 $\frac{1}{4}$ " IPS | \varnothing 1 $\frac{1}{4}$ " IPS | 0.09" ÷ 0.33" | 2.17" |
| TURBO 1 $\frac{1}{2}$ " IPS | \varnothing 1 $\frac{1}{2}$ " IPS | 0.09" ÷ 0.38" | 2.17" |
| TURBO 2" IPS | \varnothing 2" IPS | 0.09" ÷ 0.47" | 2.17" |



Transport box available



PIPE SCRAPERS - RTC

These professional rotary scrapers, designed and patented by Ritmo, are essential to prepare the plastic pipes and fittings before electrofusion welding. Practical and handy, the pipe scrapers remove the oxidation layer caused by weather and ultraviolet rays. If not removed, the oxidation layer would severely compromise the quality of the joint. Among the main construction features there is a device that makes it possible to maintain the thickness of the continuous chip constant, even if the pipe is misshaped, and to adjust the length of the surface to scrape according to the depth of the electrical coupler.

The RTC 710 features an extendable arm to scrape the exact length of the electrical coupler, which is an advantage when having to perform maintenance/repair jobs in the building site. The main chuck has four extendable arms that clamps directly the inside diameter of the pipe.

STANDARD COMPOSITION

- Pipe scraper
- Adapters kit (except for RTC 710)
- Spare blade
- Handwheel key (for RTC 315)
- Aluminum transport case
- Screwdriver and small cutter



RTC 160



RTC 315

MANUAL SCRAPER

This manual tool is used with the same principle as the RTC pipe scrapers. The MANUAL SCRAPER features a practical plastic handle and a blade. Recommended work range max. \varnothing 63 mm (2")



Manual scraper



watch the video

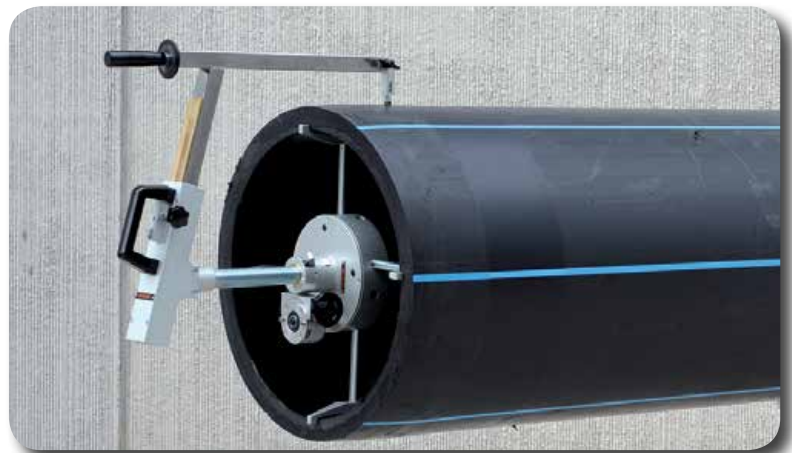

RTC 710

TECHNICAL FEATURES

| MODEL | RTC 160 | RTC 315 | RTC 710 |
|-----------------------------|---|---|---|
| Working range | \varnothing 50 ÷ 160 mm | \varnothing 75 ÷ 315 mm | \varnothing 355 ÷ 710 mm |
| External | 2" IPS ÷ 6" IPS | 3" IPS ÷ 12" IPS | 14" IPS ÷ 28" IPS |
| Internal | \varnothing 38 ÷ 154 mm (1.5" x 6") | \varnothing 58 ÷ 300 mm (2.2" x 11.8") | \varnothing 290 ÷ 675 mm (11.4" x 26.5") |
| Max scraping length | 114 mm 4.5" | 137 mm; 5.4" | 530 mm; 28.7" |
| Max Dimensions | 380 x 120 x 250 mm 14.9" x 4.7" x 9.8" | 510 x 310 x 410 mm 20" x 12.2" x 16.1" | 825 x 805 x 695 mm 32.5" x 31.7" x 27.3" |
| Dimensions transport case | 390 x 210 x 135 mm 15.3" x 8.3" x 5.3" | 230 x 500 x 270 mm 9" x 19.7" x 16.1" | 800 x 580 x 350 mm 31.5" x 22.8" x 13.8" |
| Weight only RTC | 2,50 Kg (5.5 lb) | 4,50 Kg (9.9 lb) | 16 Kg (35.8") |
| Weight standard composition | 5,65 Kg (12,5 lb) | 7,5 Kg (16.5 lb) | 39 Kg (86 lb) |

PIPE SCRAPERS - PS

Professional rotary scrapers, essential to prepare the plastic pipes and fittings before electrofusion welding. The tools has an adjustable chuck covering all the \varnothing of the working range, and a blade holder orbital arm. The PS series guarantees a constant and regular removal of the shaving. The scrapers blade holder permits the scraping of the entire electrical sleeve's length, most useful when doing on site repairs.

STANDARD COMPOSITION

- PS 180 supplied with transport bag and spare blade
- PS 400 supplied with transport case and spare blade



PS 180

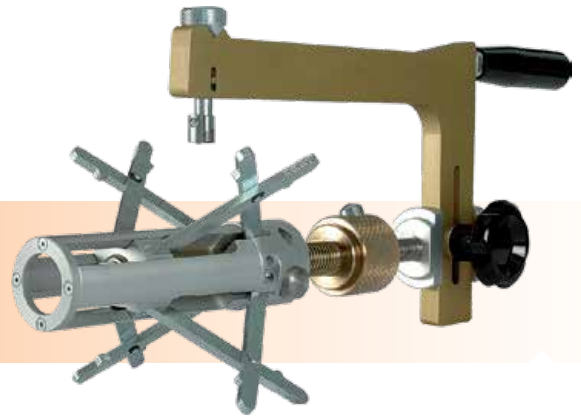

PS 400

TECHNICAL FEATURES

| MODEL | PS 180 | PS 400 |
|-----------------------------|--|--|
| Working range | \varnothing 75 ÷ 200* mm (*200 mm from SDR 6÷26) (\varnothing 2.95" ÷ 7.87") | \varnothing 137 ÷ 426 mm \varnothing 130 ÷ 391 mm |
| External | | |
| Internal | \varnothing 61 ÷ 184 mm (\varnothing 2.40" ÷ 7.24") | |
| Max scraping length | 129 mm (5.1") | 160 mm 6,2" |
| Max Dimensions | 595 x 272 x 190 mm (23.4" x 10.7" x 7.5") | 790 x 400 x 400 mm (31.1" x 15.7" x 15.7") |
| Dimensions transport case | 453 x 185 x 63 mm (17.8" x 7.3" x 2.5") | 550 x 350 x 90 mm (21.6" x 13.7" x 3.5") |
| Weight standard composition | 2,80 Kg (6.2 lb) | 5,50 Kg (12.1lb) |



UNIVERSAL ALIGNER 63

This professional tool is essential to hold pipes still and aligned during electrofusion. The UNIVERSAL ALIGNER 63 is made almost entirely in a special Aluminium alloy and features a central joint for the fixed positions at 45° and 90°, four self-centring clamps that require no adapters. The possibility to remove one part of the axis that carries the clamps and one clamp it self, allows the use of tapping tees during the fusion.

STANDARD COMPOSITION

- Aligner complete with four clamps, service spanner and transport bag

TECHNICAL FEATURES



| | |
|-----------------------------|--|
| Working range | Ø 20 ÷ 63 mm (1/2" IPS ÷ 2" IPS) |
| Max Dimensions | straight 600 x 160 x 116 mm 22.6" x 6.3" x 4.6" |
| Transport bag | 440 x 190 x 140 mm; 17.3" x 7.5" x 5.5" |
| Weight aligner | 3,40 Kg (7,5 lb) |
| Weight transport bag | 0,50 Kg (1.1 lb) |
| Weight standard composition | 3,90 Kg (8.6 lb) |

UNIVERSAL ALIGNER 160 LIGHT

This professional tool is essential to hold pipes still and aligned during electrofusion (from Ø 63 to Ø 160 mm; 2" IPS ÷ 6" IPS). The UNIVERSAL ALIGNER 160 Light is made almost entirely in a special Aluminium alloy and features a central joint for the fixed positions at 45° and 90°, four self-centring clamps that require no adapters, and on request an additional axle complete with two clamps for welding the tees. Its special quick release clamps grants a rapid extraction of the pipe once it has been welded.

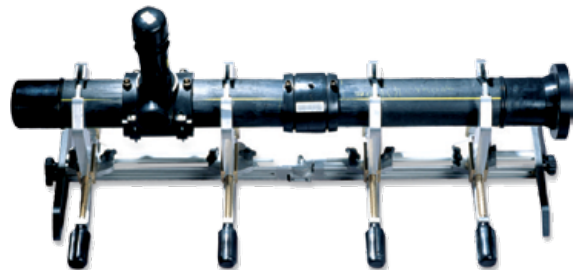

STANDARD COMPOSITION

- Aligner complete with four clamps, transport bag or wooden transport case

ON REQUEST

- A 3rd axle complete with two clamps (for welding "Tees")

TECHNICAL FEATURES

| | |
|-----------------------|--|
| Working range | Ø 63 ÷ 160 mm; 2" IPS ÷ 6" IPS |
| Max Dimensions | straight 980 x 430 x 260 mm 38.5" x 16.9" x 10.2" |
| Weight aligner | 9 Kg (19.8 lb) |
| Weight transport bag | 1,50 Kg (3.3 lb) |
| Weight transport case | 14 Kg (30,8 lb) |

ALIGNER ECO 20 - 63

ALIGNER ECO 20-63 is an essential and professional tool for the alignment and support of pipes during electrofusion.

ALIGNER ECO 20-63 is composed by two aluminum axes on which are mounted self-centering clamps made of steel. The clamps, can easily slide through the entire length of the axes. A positioning plate allows to perform welds in line, 30°, 45°, 90° and T-branches in diameters between ½" IPS ÷ 2" IPS (20 ÷ 63 mm).

The fixing of the pipes is done via cable ties (supplied) with fastener and quick release. The aligner is versatile and easy to use.



ITALY SMALL PATENTED APPLICATION
N° 202015000029036

TECHNICAL FEATURES

| | |
|----------------|--|
| Working range | Ø 20 ÷ 63 mm - ½" IPS ÷ 2" IPS |
| Max Dimensions | 640 x 120 x 83 mm; 25.2" x 4.7" x 3.3" |
| Weight aligner | 3 Kg (6.6 lb) |

ALIGNER ECO 63 - 180

ALIGNER ECO 63 - 180 is an essential and professional tool for the alignment and support of pipes during electrofusion from Ø 63 mm to 180 mm (2" IPS ÷ 6" DIPS).

The ALIGNER is entirely made of steel, featuring a central adjustable joint and pipe fastening clamps fixed on axes. The adjustable joint can be set on 4 different working positions to allow welding at preset angles such as 30°, 45°, 90°, "in line" and T welding.

Axes have V-shaped clamps positioned on them, which are equipped with pipe fastening belts. The system, along with fixing the pipe to the clamp, serves also as a centering device. Each axis has 2 guides on which the clamps are able to slide.

Practical side handles ensure an easy grip during movement and positioning, both during welding procedures, and preparation.

The aligner is available in two configurations: 2 axes and 3 axes (to weld T fittings).



TECHNICAL FEATURES

| | |
|----------------------------------|--|
| Working range | Ø 63 ÷ 180 mm; 2" IPS ÷ 6" DIPS |
| Max Dimensions 2 axes version | 915 x 140 x 130 mm 36" x 5.5" x 5.1" |
| 3 axes version | 915 x 575 x 130 mm 36" x 22.6" x 5.1" |
| Weight 2 axes version | 7,5 Kg (16.5 lb) |
| Weight 3 axes version | 10 Kg (22 lb) |

ALIGNER 125 - 500

ALIGNER 125 – 500 is an essential and professional tool for the alignment and support of pipes during electrofusion from Ø 125 mm to 500 mm (4" IPS ÷ 20" IPS)

The ALIGNER is entirely made of steel, featuring a central adjustable joint and pipe fastening clamps fixed on axes. The adjustable joint can be set on 4 different working positions to allow welding at preset angles such as 45°, 90°, "in line" and T welding. Axes have V-shaped clamps positioned on them, which are equipped with pipe fastening belts. The system, along with fixing the pipe to the clamp, serves also as a centering device. Each axis has 2 guides on which the clamps are able to slide.

Practical side handles ensure an easy grip during movement and positioning, both during welding procedures, and preparation.

The aligner is available in two configurations: 2 axes and 3 axes (to weld T fittings).



TECHNICAL FEATURES

| | |
|----------------------------------|---|
| Working range | Ø 125 ÷ 500 mm; 4" IPS ÷ 20" IPS |
| Max Dimensions 2 axes version | 1815 x 610 x 410 mm 71.5" x 24" x 16.1" |
| 3 axes version | 1815 x 1230 x 410 mm 71.5" x 48.4" x 16.1" |
| Weight 2 axes version | 38 Kg (83,8 lb) |
| Weight 3 axes version | 52 Kg (114.6 lb) |



TECHNICAL FEATURES

CHAMFERING

Chamfering tools are designed to make a bevel on the outside edge of a pipe end for socket fusion and electrofusion.

This Chamfer allows heater faces and socket fittings to be easily pushed onto the pipe end.

| MODEL | Working range mm | Working range in | Materials |
|---------------------|------------------|------------------|-------------------------|
| CHAMFERING 20 | Ø 20 mm | - | HDPE, PB, PP, PVC, PVDF |
| CHAMFERING 25 | Ø 25 mm | - | HDPE, PB, PP, PVC, PVDF |
| CHAMFERING 32 | Ø 32 mm | - | HDPE, PB, PP, PVC, PVDF |
| CHAMFERING 40 | Ø 40 mm | - | HDPE, PB, PP, PVC, PVDF |
| CHAMFERING ½" CTS | - | ½" CTS | HDPE, PB, PP, PVC, PVDF |
| CHAMFERING ¾" IPS | - | ¾" IPS | HDPE, PB, PP, PVC, PVDF |
| CHAMFERING 1" IPS | - | 1" IPS | HDPE, PB, PP, PVC, PVDF |
| CHAMFERING 1 ¼" IPS | - | 1 ¼" IPS | HDPE, PB, PP, PVC, PVDF |
| CHAMFERING 1 ½" IPS | - | 1 ½" IPS | HDPE, PB, PP, PVC, PVDF |
| CHAMFERING 2" IPS | - | 2" IPS | HDPE, PB, PP, PVC, PVDF |

MAYA 20-63

Manual tool for beveling the ends of plastic pipes for electrofusion, socket fusion, pipe connection. Maya 20-63 covers a range from 20 to 63 mm.

Compact and lightweight this chamfering tool proves to be a useful tool to always have in the toolbox.



TECHNICAL FEATURES

| | |
|---------------|---------------------------|
| Working range | 20 ÷ 63 mm |
| Dimensions | 60 x 80 mm 2.6" x 3.1" |
| Weight | 90 gr (0,2 lb) |



BEVELERS

SME 1 - SME 2 PLUS

These are professional tools for bevelling the ends of plastic pipes up to \varnothing 315 mm (10" IPS), that will be inserted into electrical couplers or plug-in joints. The SME 1 is made in plastic; SME 2 PLUS is made in a special Aluminum alloy. The special shape of the blades and the non-stick coating (PTFE) of the walls, allow a quick and easy bevel of the pipe.

SUPPLIED WITH

- Beveler body with blade



TECHNICAL FEATURES

| | SME 1 | SME 2 PLUS |
|---------------|--|---|
| Working range | \varnothing 32 ÷ 160 mm; 1" IPS ÷ 5" IPS | \varnothing 40 ÷ 315 mm; 1 1/4" IPS ÷ 10" IPS |
| Materials | HDPE, PB, PP, PVC, PVDF | HDPE, PB, PP, PVC, PVDF |
| Thickness | max 10 mm; 0.4" | max 35 mm; 1.3" |
| Dimensions | 76 x 107 x 240 mm 3" x 4,2" x 9,4" | 128 x 235 x 310 mm 5" x 9" x 12" |
| Weight | 0,8 Kg (1.4 lb) | 1,50 Kg (3.3 lb) |

HOLDER

Socket fitting holder for 2"



COLD RING

Useful tool used to clamp, hold and round at the desired place the pipe in order to weld it properly.



TECHNICAL FEATURES

| Model | Working range |
|----------------------|--------------------------|
| Cold Ring 20 | \varnothing 20 mm |
| Cold Ring 25 | \varnothing 25 mm |
| Cold Ring 32 | \varnothing 32 mm |
| Cold Ring 40 | \varnothing 40 mm |
| Cold Ring 50 | \varnothing 50 mm |
| Cold Ring 63 | \varnothing 63 mm |
| Cold Ring 1/2" CTS | \varnothing 1/2" CTS |
| Cold Ring 1" CTS | \varnothing 1" CTS |
| Cold Ring 1/2" IPS | \varnothing 1/2" IPS |
| Cold Ring 3/4" IPS | \varnothing 3/4" IPS |
| Cold Ring 1" IPS | \varnothing 1" IPS |
| Cold Ring 1 1/4" IPS | \varnothing 1 1/4" IPS |
| Cold Ring 1 1/2" IPS | \varnothing 1 1/2" IPS |
| Cold Ring 2" IPS | \varnothing 2" IPS |

REROUNDERS FOR PLASTIC PIPE

Rerounders for plastic pipes: products for the jobsite.

The mechanical thread of these steel-made products help remodel the ends of ovalized pipes that need to be welded by electrofusion.

The manual clamping of the tool stems pushes the ovalized end till its reshaping respects the ovalization range required by most standards, therefore allowing its insertion into an electrical coupling - and avoiding the cost of eliminating a good pipe. The 3 rerounders cover the following diameters range: 250-400 model for OD from 250 to 400 mm; 450-560 model for OD from 450 to 560 mm, and 630-800 model for OD from 630 to 800 mm.

Each one of them is sold separately, with a steel transport box. (For model 450 - 560 and 630 - 800 steel case with 2 wheels).

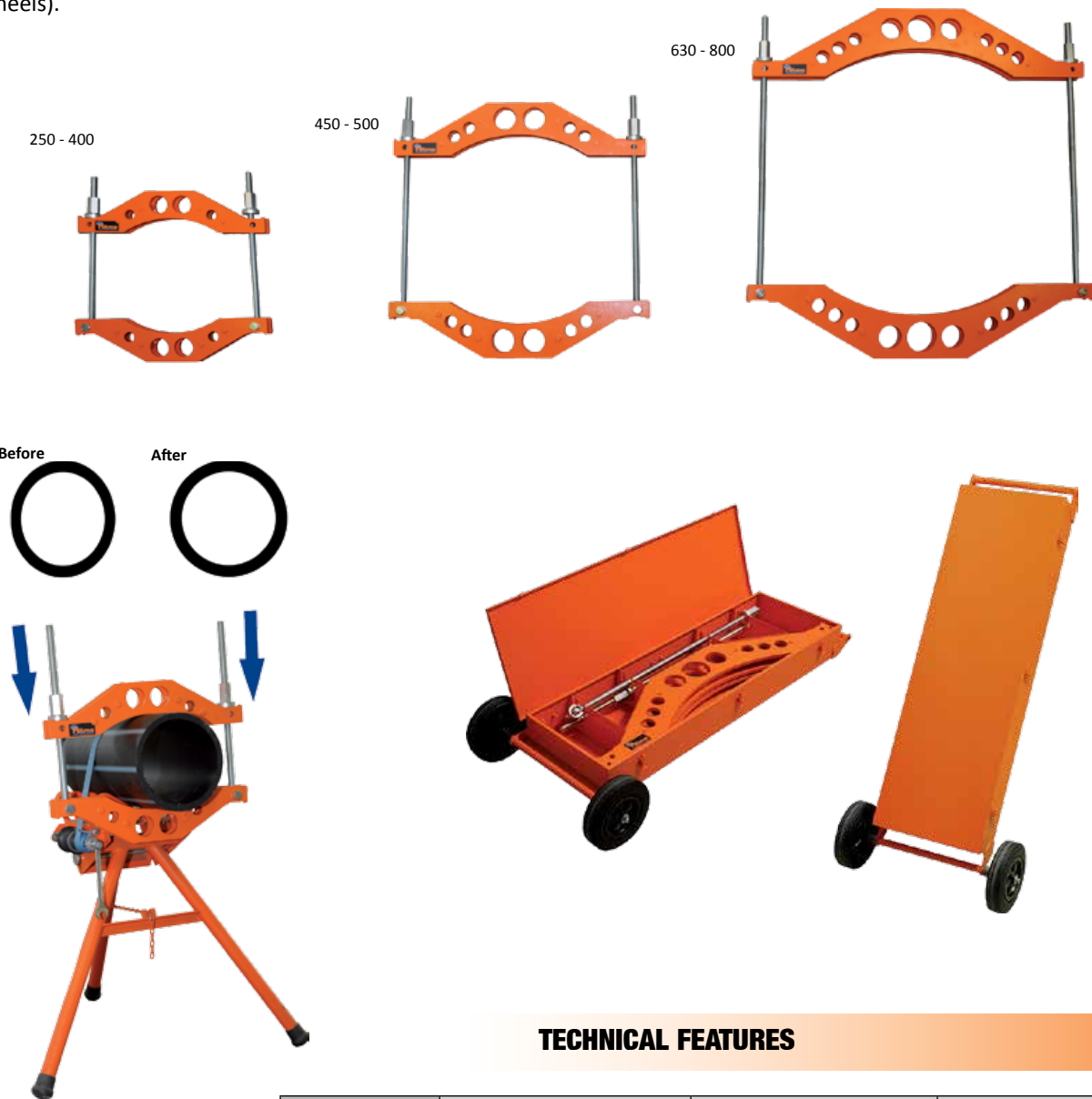

TECHNICAL FEATURES

| MODEL | Rerounders 250 - 400 10" IPS ÷ 14" DIPS | Rerounders 450 - 560 18" IPS ÷ 22" IPS | Rerounders 630 - 800 24" DIPS ÷ 30" IPS |
|------------|--|--|---|
| Dimensions | 610 x 255 x 120 mm 24" x 10" x 4.7" | 980 x 495 x 200 mm 38.5" x 19.5" x 7.9" | 1240 x 555 x 200 mm 47,2" x 21.8" x 7.9" |
| Weight | 27 Kg (59.5 lb) | 41 Kg (90.4 lb) | 60 Kg (132.3 lb) |

SQUEEZER 63

The SQUEEZER 63 is a manual tool. Easy and fast to apply, the SQUEEZER is useful in the worksite to stop the gas or water flow in the Polyethylene pipelines from \varnothing 16 to 63 mm / SDR 11 - SDR 17.

The squeezing action runs by a movable cylindric bar and by an opposite one.

The second bar can be removed to permit the pipe insertion. Two special stop templates with 4 positions (on the movable bar sides) assure a safe pipe squeeze on all working range diameters.

TECHNICAL FEATURES

| | |
|--------------------|---|
| Working range | \varnothing 16 ÷ 63 mm SDR 11 SDR 17 |
| Operation | Manual |
| Overall Dimensions | 325 x 70 x 330 mm 12.8" x 2.7" x 13" |
| Weight | 5,3 Kg (11.7 lb) |

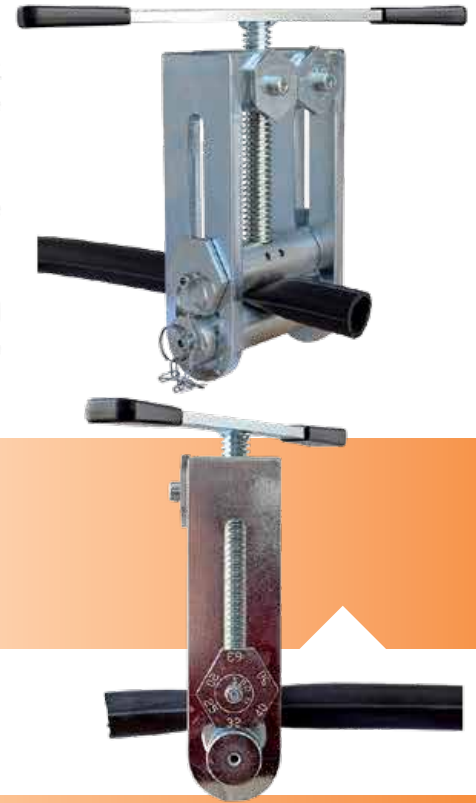

SQUEEZER 63 - 200 HYDRAULIC

SQUEEZER 63-200 is an hydraulic squeezer, very effective and useful in the worksite, to stop the gas or water flow in the HDPE pipelines from \varnothing 63 to 200 mm - SDR 11, SDR 17.

Thanks to this all the works on the line can be done in the highest safety conditions. The squeezing action on the pipe is possible thanks to a hydraulic cylinder which is manually actuated by the operator with a pressing lever. The resulting strength is transferred to two cylindrical rods which squeeze the pipe till the interruption of the flow.

The SQUEEZER 63-200 is easy to transport thanks to two handles and its steel frame. On its sides the SQUEEZER 63-200 is equipped with two metallic rods for safety protection in case of pressure losses or accidental impacts. Moreover the standard configuration of the SQUEEZER 63-200 includes the stoppers for SDR 11 and SDR 17 to set according to the pipes diameter.

TECHNICAL FEATURES

| | |
|--------------------|--|
| Working range | \varnothing 63 ÷ 200 mm SDR 11 SDR 17 |
| Operation | Hydraulic |
| Overall Dimensions | 476 x 165 x 722 mm 18.7" x 6.5" x 28,4" |
| Weight | 45 Kg (99 lb) |



SOCKET WELDERS

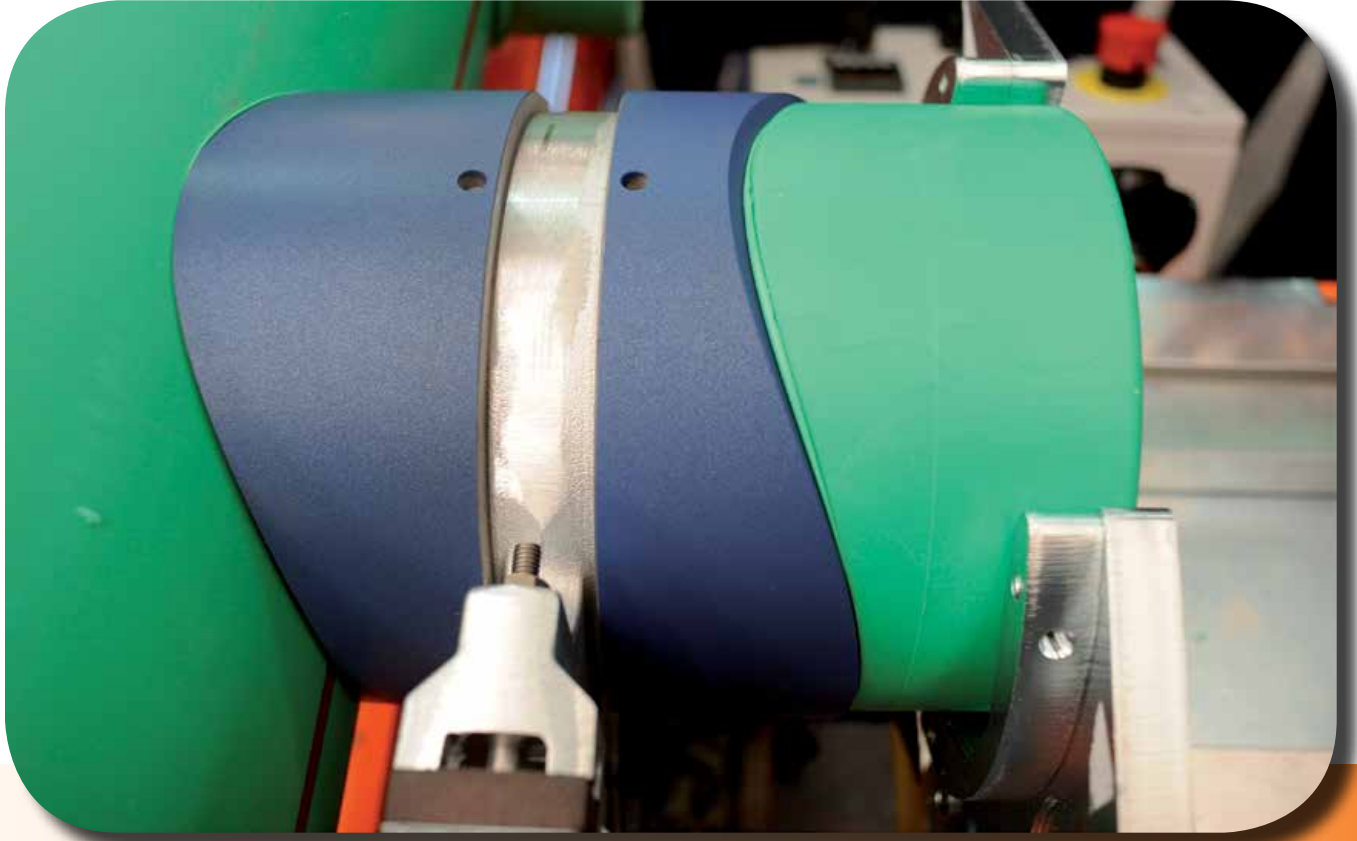

MANUAL EQUIPMENT

| WORKING RANGE Ø mm | 16 | 20 | 25 | 32 | 40 | 50 | 63 | 75 | 90 | 110 | 125 |
|--------------------|----|----|----|----|----|----|----|----|----|-----|-----|
| R 25 | 16 | 20 | 25 | | | | | | | | |
| R 63 | 16 | 20 | 25 | 32 | 40 | 50 | 63 | | | | |
| R 125 Q | 16 | 20 | 25 | 32 | 40 | 50 | 63 | 75 | 90 | 110 | 125 |
| WORKING RANGE Ø mm | 16 | 20 | 25 | 32 | 40 | 50 | 63 | 75 | 90 | 110 | 125 |

SOCKET FUSION MACHINE

| WORKING RANGE Ø mm | 20 | 25 | 32 | 40 | 50 | 63 | 75 | 90 | 110 | 125 |
|--------------------|----|----|----|----|----|----|----|----|-----|-----|
| PRISMA JIG | 20 | 25 | 32 | 40 | 50 | 63 | | | | |
| PRISMA 125 LIGHT | 20 | 25 | 32 | 40 | 50 | 63 | | | | |
| PRISMA 125 | | 25 | 32 | 40 | 50 | 63 | 75 | 90 | 110 | 125 |
| WORKING RANGE Ø mm | 20 | 25 | 32 | 40 | 50 | 63 | 75 | 90 | 110 | 125 |

 ON REQUEST

SADDLE SOCKET FUSION MACHINE

| WORKING RANGE Ø mm | |
|--------------------|---|
| PRISMA UP 90 | MAIN PIPE 63 ÷ 250 mm SADDLE FITTING 20 ÷ 90 mm |
| FM 630-125 | MAIN PIPE 50 ÷ 630 mm SADDLE FITTING 20 ÷ 125 mm |

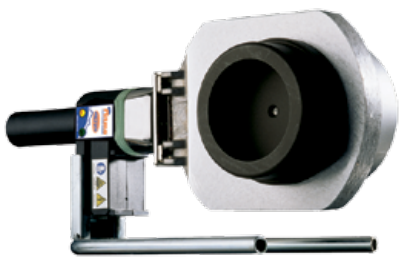

R 125 Q



R 63



R 25

MANUAL EQUIPMENT

Manual SOCKET welders for joining pipes and fittings, in compliance with the standards in force. They feature an aluminum heating plate and a practical, heat-insulated plastic handle. They can weld HDPE, PP, PP-R, PVDF pipes and fittings, and they're characterized by different shapes and working ranges, suitable for different applications. They're available with an adjustable electronic thermoregulator (TE), or with a fixed electronic thermostat (TFE).

This new TFE control system features a new self-diagnostic device, provided with an alarm, which would alert the operator in case of anomaly; at the same time, the heating element would switch off automatically. Thanks to an algorithm PID microcontroller, combined with a platinum sensor, the temperature control system can react faster to the external temperature fluctuations, and guarantee higher reliability and longer durability.

STANDARD COMPOSITION

- Socket welder
- Fork support
- Bench vice (except R 25)
- Allen wrench
- Pin for sockets & spigots

ON REQUEST

- Bench vice (for R 25)
- Sockets and spigots (male/female)
- Carrying case in electro-painted steel
- R 63 Insulated bag



TECHNICAL FEATURES

| TYPE: TE, TFE | R 25 | R 63 | R 125 Q |
|---------------------|--|--|--|
| Working range | up to \varnothing 25 mm | up to \varnothing 63 mm | up to \varnothing 125 mm |
| Materials | HDPE, PP, PP-R PB, PVDF | HDPE, PP, PP-R PB, PVDF | HDPE, PP, PP-R PB, PVDF |
| Power supply (TE) | 230 V S. Ph. 50/60 Hz | 230 V S. Ph. 50/60 Hz | 230 V S. Ph. 50/60 Hz |
| Power supply (TFE) | 110 V S. Ph. 50/60 Hz 230 V S. Ph. 50/60 Hz | 110 V S. Ph. 50/60 Hz 230 V S. Ph. 50/60 Hz | 110 V S. Ph. 50/60 Hz 230 V S. Ph. 50/60 Hz |
| Max. absorbed power | 500 W | 800 W | 1400 W |
| Working temperature | 260° C (\pm 10° C) TFE 500° F (\pm 50° F) TFE 180° ÷ 290° C TE 356° ÷ 554° F TE | 260° C (\pm 10° C) TFE 500° F (\pm 50° F) TFE 180° ÷ 290° C TE 356° ÷ 554° F TE | 260° C (\pm 10° C) TFE 500° F (\pm 50° F) TFE 180° ÷ 290° C TE 356° ÷ 554° F TE |
| Ambient temperature | -5° ÷ 40° C (23° ÷ 104° F) | -5° ÷ 40° C (23° ÷ 104° F) | -5° ÷ 40° C (23° ÷ 104° F) |
| Weight | 1,44 Kg (3.1 lb) | 1,82 Kg (4 lb) | 3,16 Kg (7 lb) |
| Dimensions | 115 x 50 x 320 mm 4.5" x 2" x 12.6" | 175 x 50 x 360 mm 6.9" x 2" x 14.1" | 175 x 50 x 395 mm 6.9" x 2" x 15.5" |

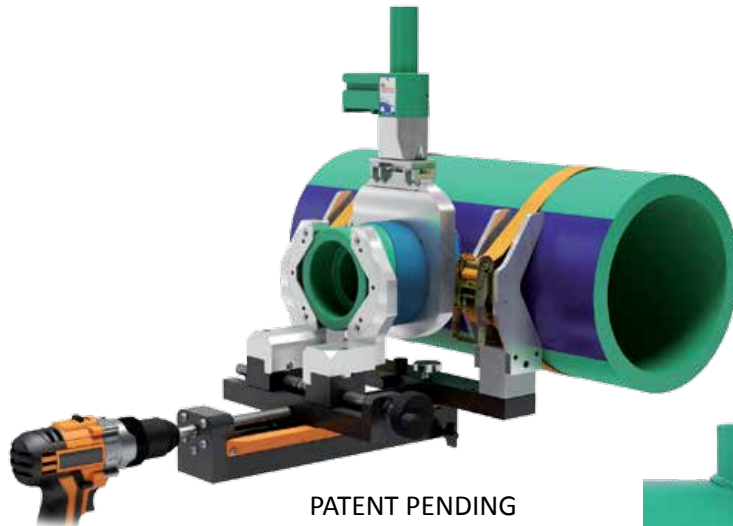

watch the video

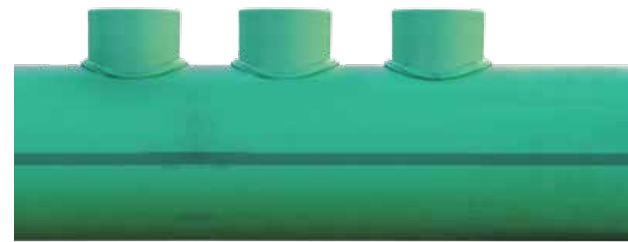

PRISMA UP 90

Prisma Up 90 is a special PP-R saddle socket fusion machine. The machine is designed to weld special PP-R joints like collectors and reduced branches. The light weight of the machine enables an easy fixing. Working range: main pipe \varnothing 63 ÷ 250 mm; branch pipe: 20 ÷ 90 mm.

The machine is composed of two assembly parts: a main jaws bracket and a frame with fitting carriage jaws. The main jaws bracket is light for an easy fixing on the main pipe. The fitting carriage jaws are designed to mount a driller with hole saw and fitting.

The welding machine makes a perfect centering of drilling and socket weld as well as the perfect alignment between pipe and fitting.

The saddle sockets installed on a manual socket welder, heat up the pipe and fitting surfaces. After the heating phase, the fitting is pushed inside the pipe thanks to a screw system which ensures a perfect alignment of the fittings. Available saddle sockets or major brands.

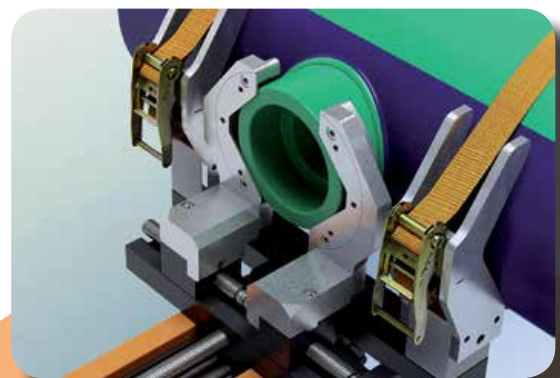
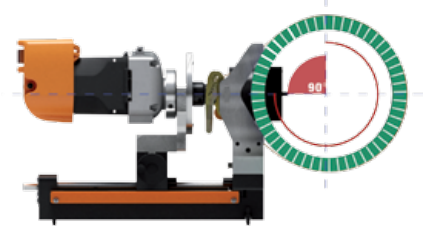

TECHNICAL FEATURES

PLUS

**WORK
IN TIGHT SPACES**

**PERFECT
CENTERING
PIPE/FITTING**

LIGHT WEIGHT

| | |
|--|---|
| Working range - main pipe | 63 ÷ 250 mm |
| Working range - branch pipe | 20 ÷ 90 mm |
| Materials | PP-R |
| Power supply | 110 V or 230 V S.Phase 50/60 Hz |
| Total absorbed power driller | 1200 W |
| Total absorbed power R 125 Q | 1400 W |
| Working temperature R 125 Q | 260° (± 10° C) |
| Overall dimensions (without driller, heater) | 410 x 410 x 270 mm 16.4" x 16.4" x 10.6" |
| Overall dimensions (without driller) | 410 x 410 x 407 mm 16.4" x 16.4" x 16" |
| Weight: machine without driller, heater | 10,8 Kg (23.8 lb) |
| Weight: main jaws bracket | 2,7 Kg (5.9 lb) |
| Weight: frame with fitting carriage jaws | 8, 1 Kg (17.8 lb) |
| Weight: driiller | 3, 5 Kg (7.7 lb) |
| Transport case Prisma UP 90 | 390 x 350 x 500 mm 15.3" x 13.8" x 19.7" |
| Transport case Socket welder | 405 x 175 x 50 mm 15.9" x 6.8" x 1.9" |

STANDARD COMPOSITION

- Welding machine body complete with: frame, fittings carriage jaws, main jaw bracket assembly
- Electric drill
- R 125 Q TFE hand socket welder with transport case
- Transport case for machine body

ON REQUEST



Saddle sockets
of major Brands



Hole Saw

- and:
- Clamp set for socket fusion pipe on reducer
 - Support for manifolds





PRISMA JIG

The PRISMA JIG is a compact socket welding machine for HDPE, PP and PP-R, PVDF, PB OD 20* ÷ 125 mm (standard composition steel clamps from Ø 63 to 125 mm; on request clamps from Ø 20 to 63 mm). The machine displays a steel frame that can be used as a support to the aligning body; the unit distinguishes itself by being able to work in tight spaces, after a swift releasing manoeuvre of the frame.

The PRISMA JIG has two trolleys, a fixed and a movable one, with practical closing handwheels in order to ensure a perfect grip in between clamp and pipe/fitting. The machine also features steel auto-centering clamps: a special clamp for the fitting, and a couple of paired clamps designed to keep the pipe in position. The trolley closing and opening operations are performed by a “mutual” starter. The special fittings clamp is placed on the fixed trolley. Whenever the type of work requires a different clamping configuration, it is rather easy to unlock and change the machine’s operativeness.

The heating operation is performed by the R 125 Q hand socket welder with TFE fixed temperature control. The main distinctiveness of the TFE device is its security: an acoustic auto-diagnosis alarm indicates when the heating plate has reached the working temperature, but also shuts off the heating plate automatically if any anomaly happens. Thanks to a combined control system, the TFE device responds rather quickly to any temperature fluctuation forced by external causes; on the other hand, it also gives a greater stability, welding precision and reliability in time. A sustaining handle may be placed at the heating plate, in order to simplify the working phases.

The R 125 Q is available in 110 and 230 V. The welding machine is available in two versions, depending on the type of sockets & spigots supplied: Type A and Type B.

STANDARD COMPOSITION

- Machine body complete with clamps and frame
- R 125 Q TFE hand socket welder
- Socket welder fork support
- Clamps for OD 63-75-90-110-125 mm (A or B type) sockets & spigots
- Transport case for socket welder and sockets & spigots
- Transport case for machine body
- Sustaining handle and tool kit



TECHNICAL FEATURES

PLUS

**CLAMPS
20 ÷ 63mm
(on request)**

**WORK
IN TIGHT SPACES**

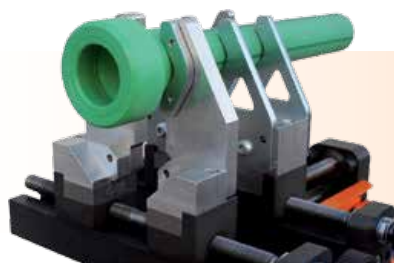

| | |
|-----------------------------------|--|
| Working range | 63 ÷ 125 mm standard 20 ÷ 63 mm clamps on request |
| Materials | HDPE, PP, PP-R, PB, PVDF |
| Power supply | 110 V Single Phase 50/60 Hz 230 V Single Phase 50/60 Hz |
| Total absorbed power | 1400 W |
| Working temperature | 260° (± 10° C) 500° F (± 50° F) |
| Outside temperature range | -5° ÷ 40° C (23° ÷ 104° F) |
| Dimensions machine body | 400 x 337 x 267 mm 15.7" x 13.3" x 10.5" |
| Dimensions machine body and frame | 400 x 337 x 382 mm 15.7" x 13.3" x 15" |
| Socket welder | 175 x 50 x 395 mm 6.9" x 2" x 15.5" |
| Transport case Prisma Jig | 390 x 350 x 500 mm 15.3" x 13.8" x 19.7" |
| Transport case Socket welder | 490 x 310 x 485 mm |
| Weight machine body | 9,55 Kg (21 lb) |
| Weight frame Prisma Jig | 2,5 Kg (5.5 lb) |
| Weight Socket welder | 3,16 Kg (6,8 lb) |





PRISMA 125 LIGHT

PRISMA 125 LIGHT is a field machine for socket welding method, for pipe and fittings in HDPE, PP, PP-R, PVDF, PB for diameters included between 20* ÷ 125 mm (standard composition steel clamps from Ø 63 to 125 mm; on request clamps from Ø 20 to 63 mm). Leading particulars are the restricted weight, minimum overall dimensions and versatility.

Featuring: a machine body, a self-centring clamp for locking the pipes, a self-centring clamp for locking the fittings, an extractable socket welder with an automatic electronic temperature, fitting holder and a special bench vice so the machine can be used on a work bench.

STANDARD COMPOSITION

- Welding machine Prisma 125 Light with steel case
- Socket fusion plate R 125 Q TFE
- Socket and spigot Ø 63 ÷ 125 mm
(on request clamps from Ø 20 to 63 mm)
- Carrying box



TECHNICAL FEATURES

| | |
|-----------------------------|--|
| Working range | 63 ÷ 125 mm standard 20 ÷ 63 mm clamps on request |
| Materials | HDPE, PP, PP-R, PB, PVDF |
| Power supply | 110 V Single Phase 50/60 Hz 230 V Single Phase 50/60 Hz |
| Max. absorbed power | 1400 W |
| Working temperature | 260° (± 10° C); 500° F (± 50° F) |
| Outside temperature range | -5° ÷ 40° C; (23° ÷ 104° F) |
| Weight standard composition | 27 Kg (59.5 lb) |
| Dimensions machine body | 620 x 670 x 610 mm 24.4" x 26.4" x 24" |



PRISMA 125

This workshop/construction site welding machine is suitable for the socket fusion of pipes and fittings up to an OD of 125 mm, in accordance with the standards in force.

The PRISMA 125 is composed of a machine body featuring a selector for the welding depths of the different diameters, four self-centering steel clamps for locking pipes and fittings (different brands), a self-centring socket welder with electronic temperature control, a device for the maximum heating depth, a sliding trolley, a tripod to support the pipe, a set of sockets and spigots for socket fusion from Ø 25 to Ø 125 mm with steel case.

The welding machine is available in two versions, depending on the type of sockets & spigots supplied:

PRISMA 125 type A and PRISMA 125 type B.

STANDARD COMPOSITION

- Machine body complete with an electronic socket welder
- Steel case complete with sockets and spigots from Ø 25 to Ø 125 mm and tool kit
- Pipe support tripod
- Sliding trolley

TECHNICAL FEATURES

| | |
|-----------------------------------|--|
| Working range | 25 ÷ 125 mm |
| Materials | HDPE, PP, PP-R, PB, PVDF |
| Power supply | 110 V Single Phase 50/60 Hz 230 V Single Phase 50/60 Hz |
| Max. absorbed power | 1400 W |
| Working temperature | 180° ÷ 280° C (356° ÷ 536° F) |
| Outside temperature range | -10° ÷ 40° C (14 ÷ 104° F) |
| Time to reach welding temperature | ~ 10' |
| Weight Prisma 125 only | 100 Kg (200.5 lb) |
| Dimensions machine working | 1080 x 840 x 580 mm 42.5" x 33" x 22.8" |
| Transport case wood | 1500 x 800 x 1300 mm 59" x 31.5" x 51.2" |



FM 630 - 125

Workshop Machine for the fabrication of PP-R manifolds

Materials: PP; PP-R

The machine is composed by a support frame with two self-centering clamps that are free to slide independently along the whole length.

An off-set work station also free to move along the frame where are positioned: the welding machine, the driller, two control panels and the power supplier.

The drilling machine always guarantees a centered hole in the middle of the pipe.

The trolley system of the work station, with an electric motion regulated by a potentiometer, always allows easy operations during the movement, drilling and welding phases. The machine is equipped with two anti-tilt systems at the sides.

Hole saws

Dimensions of hole saws and connection shafts depend on physical characteristics of the PP-R fittings.

Welding sockets:

Saddle sockets available for different brands.



TECHNICAL FEATURES

| | |
|---|---|
| Working range Main Pipe OD range | 50 ÷ 630 mm |
| Working range Reduced Pipe OD range | 20 ÷ 125 mm |
| Inserts | from 50 to 560 mm |
| Material | PP-R |
| Power supply | 230 V single phase 50/60 HZ |
| Total absorbed power | 3100 W |
| Dimensions machine | 3967 x 1895 x 1571 mm 156.1" x 74.6" x 61.8" |
| Weight machine | 1100 Kg (2.425 lb) |



S02 - CROSS-OVER FITTINGS

Pneumatic workshop machine suitable for the construction of cross over special fittings by means of thermo-forming segments of Polypropylene Random (PP-R) pipe.

The S02 features:

- A bench with pneumatic cutter for cutting segments of pipe to size with a box for collecting the pieces, and a heating unit able to prepare up to 10 pipe segments, ranging from \varnothing 20 to 32 mm;
- A dual-station pressing bench with built-in cooling unit.

SUPPLIED WITH

- Bench complete with cutter, box for collecting the pieces, and heater;
- Dual station pressing bench with cooler and one one mould for each diameter previewed (from \varnothing 20 to \varnothing 32 mm).



watch the video



TECHNICAL FEATURES

| | |
|------------------------|--|
| Working range | \varnothing 20 ÷ 32 mm |
| Materials | PP-R For other materials contact RITMO S.P.A. |
| Power supply | 400 V Three Phase 50/60 Hz |
| Total absorbed power | 4500 W |
| Hourly output max | ~ 140 pieces |
| Dimensions station one | 1500 x 1030 x 1100 mm 59" x 40.5" x 43.3" |
| Dimensions station Two | 1400 x 500 x 1250 mm 55.1" x 19.7" x 49.2" |



SOCKET & SPIGOT

These accessories are necessary for the socket fusion of pipes and fittings.

They were designed in accordance to the German standards, for which there are two version, "A" and "B", different in size and welding coupling depths.

Type A

Ø16 SOCKET & SPIGOT (A)
 Ø 20 SOCKET & SPIGOT (A)
 Ø 25 SOCKET & SPIGOT (A)
 Ø 32 SOCKET & SPIGOT (A)
 Ø 40 SOCKET & SPIGOT (A)
 Ø 50 SOCKET & SPIGOT (A)
 Ø 63 SOCKET & SPIGOT (A)
 Ø 75 SOCKET & SPIGOT (A)
 Ø 90 SOCKET & SPIGOT (A)
 Ø 110 SOCKET & SPIGOT (A)
 Ø 125 SOCKET & SPIGOT (A)

Type B

Ø16 SOCKET & SPIGOT (B)
 Ø 20 SOCKET & SPIGOT (B)
 Ø 25 SOCKET & SPIGOT (B)
 Ø 32 SOCKET & SPIGOT (B)
 Ø 40 SOCKET & SPIGOT (B)
 Ø 50 SOCKET & SPIGOT (B)
 Ø 63 SOCKET & SPIGOT (B)
 Ø 75 SOCKET & SPIGOT (B)
 Ø 90 SOCKET & SPIGOT (B)
 Ø 110 SOCKET & SPIGOT (B)
 Ø 125 SOCKET & SPIGOT (B)

Type "AQ"

Ø 20 SOCKET & SPIGOT TYPE-AQ
 Ø 25 SOCKET & SPIGOT TYPE-AQ
 Ø 32 SOCKET & SPIGOT TYPE-AQ
 Ø 40 SOCKET & SPIGOT TYPE-AQ
 Ø 50 SOCKET & SPIGOT TYPE-AQ
 Ø 63 SOCKET & SPIGOT TYPE-AQ
 Ø 75 SOCKET & SPIGOT TYPE-AQ
 Ø 90 SOCKET & SPIGOT TYPE-AQ
 Ø 110 SOCKET & SPIGOT TYPE-AQ
 Ø 125 SOCKET & SPIGOT TYPE-AQ

Saddles socket CTS

Ø ½" CTS SOCKET & SPIGOT
 Ø ¾" CTS SOCKET & SPIGOT
 Ø 1" CTS SOCKET & SPIGOT
 Ø 1¼" CTS SOCKET & SPIGOT

Saddles socket IPS

Ø ½" IPS SOCKET & SPIGOT
 Ø ¾" IPS SOCKET & SPIGOT
 Ø 1" IPS SOCKET & SPIGOT
 Ø 1¼" IPS SOCKET & SPIGOT
 Ø 1 ½" IPS SOCKET & SPIGOT
 Ø 2" IPS SOCKET & SPIGOT
 Ø 3" IPS SOCKET & SPIGOT
 Ø 4" IPS SOCKET & SPIGOT

Hole repairing Sockets and accessories

Ø 7 mm HOLE REPAIRING SOCKET & SPIGOT
 Ø 8 mm HOLE REPAIRING SOCKET & SPIGOT
 Ø 11 mm HOLE REPAIRING SOCKET & SPIGOT
 CLOSING TAPS SET - PE (20 PCS)
 CLOSING TAPS SET - ORANGE PP (20 PCS)

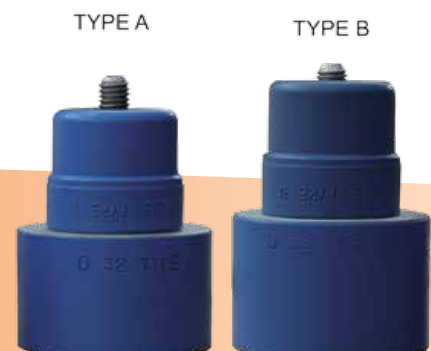



*** Saddle sockets metric
"AQ"**

- Ø 40-20/25 AQ SADDLE SOCKET
- Ø 50-20/25 AQ SADDLE SOCKET
- Ø 63-20/25 AQ SADDLE SOCKET
- Ø 63-32 AQ SADDLE SOCKET
- Ø 75-20/25 AQ SADDLE SOCKET
- Ø 75-32 AQ SADDLE SOCKET
- Ø 75-40 AQ SADDLE SOCKET
- Ø 90-20/25 AQ SADDLE SOCKET
- Ø 90-32 AQ SADDLE SOCKET
- Ø 90-40 AQ SADDLE SOCKET
- Ø 110-20/25 AQ SADDLE SOCKET
- Ø 110-32 AQ SADDLE SOCKET
- Ø 110-40 AQ SADDLE SOCKET
- Ø 110-50 AQ SADDLE SOCKET
- Ø 125-20/25 AQ SADDLE SOCKET
- Ø 125-32 AQ SADDLE SOCKET
- Ø 125-40 AQ SADDLE SOCKET
- Ø 125-50 AQ SADDLE SOCKET
- Ø 125-63 AQ SADDLE SOCKET
- Ø 160-20/25 AQ SADDLE SOCKET
- Ø 160-32 AQ SADDLE SOCKET
- Ø 160-40 AQ SADDLE SOCKET
- Ø 160-50 AQ SADDLE SOCKET
- Ø 160-63 AQ SADDLE SOCKET
- Ø 160-75 AQ SADDLE SOCKET
- Ø 160-90 AQ SADDLE SOCKET
- Ø 200-20/25 AQ SADDLE SOCKET
- Ø 200-50 AQ SADDLE SOCKET
- Ø 200-63 AQ SADDLE SOCKET
- Ø 200-75 AQ SADDLE SOCKET
- Ø 200-90 AQ SADDLE SOCKET
- Ø 200-110 AQ SADDLE SOCKET
- Ø 200-125 AQ SADDLE SOCKET
- Ø 250-50 AQ SADDLE SOCKET
- Ø 250-63 AQ SADDLE SOCKET
- Ø 250-75 AQ SADDLE SOCKET
- Ø 250-90 AQ SADDLE SOCKET
- Ø 250-110 AQ SADDLE SOCKET
- Ø 250-125 AQ SADDLE SOCKET

*** Saddle sockets metric
"N"**

- Ø 40-20/25 N SADDLE SOCKET
- Ø 50-20/25 N SADDLE SOCKET
- Ø 63-20/25 N SADDLE SOCKET
- Ø 63-32 N SADDLE SOCKET
- Ø 75-20/25 N SADDLE SOCKET
- Ø 75-32 N SADDLE SOCKET
- Ø 90-20/25 N SADDLE SOCKET
- Ø 90-32 N SADDLE SOCKET
- Ø 90-40 N SADDLE SOCKET
- Ø 90-50 N SADDLE SOCKET
- Ø 110-20/25 N SADDLE SOCKET
- Ø 110-32 N SADDLE SOCKET
- Ø 110-40 N SADDLE SOCKET
- Ø 110-50 N SADDLE SOCKET
- Ø 110-63 N SADDLE SOCKET
- Ø 125-20/25 N SADDLE SOCKET
- Ø 125-32 N SADDLE SOCKET
- Ø 125-40 N SADDLE SOCKET
- Ø 125-50 N SADDLE SOCKET
- Ø 125-63 N SADDLE SOCKET
- Ø 160-20/25 N SADDLE SOCKET
- Ø 160-32 N SADDLE SOCKET
- Ø 160-40 N SADDLE SOCKET
- Ø 160-50 N SADDLE SOCKET
- Ø 160-63 N SADDLE SOCKET
- Ø 200-20/25 N SADDLE SOCKET
- Ø 200-32 N SADDLE SOCKET
- Ø 200-40 N SADDLE SOCKET
- Ø 200-50 N SADDLE SOCKET
- Ø 200-63 N SADDLE SOCKET
- Ø 250-20/25 N SADDLE SOCKET
- Ø 250-32 N SADDLE SOCKET
- Ø 250-40 N SADDLE SOCKET
- Ø 250-50 N SADDLE SOCKET
- Ø 250-63 N SADDLE SOCKET
- Ø 315-32 N SADDLE SOCKET
- Ø 315-40 N SADDLE SOCKET
- Ø 315-50 N SADDLE SOCKET
- Ø 315-63 N SADDLE SOCKET

* Contact RITMO S.P.A. for more details

FITTINGS FABRICATION MACHINES

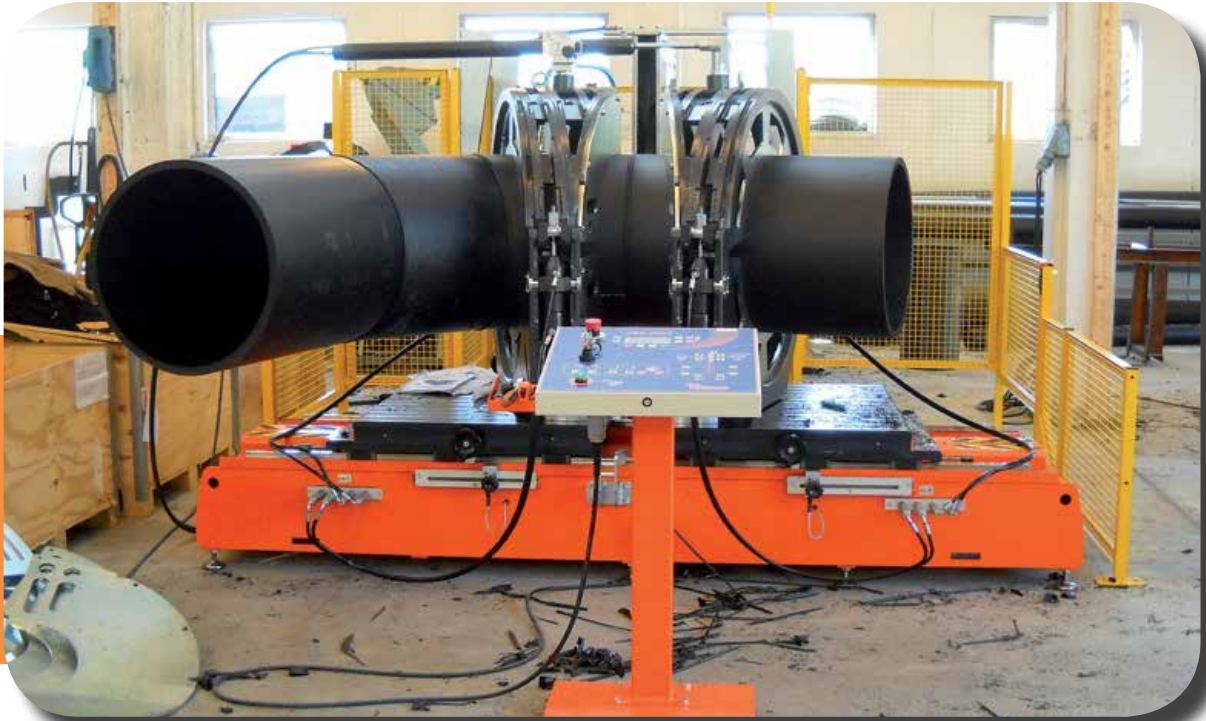

| WORKING RANGE Ø mm | 32 | 40 | 50 | 63 | 75 | 90 | 110 | 125 | 140 | 160 | 180 | 200 | 225 | 250 | 280 | 315 | 355 | 400 | 450 | 500 | 560 | 630 | 710 | 800 | 900 | 1000 | 1200 | 1400 | 1600 | |
|---------------------------|-----------|-----------|-----------|-----------|-----------|-----------|------------|------------|------------|------------|------------|------------|------------|------------|------------|------------|------------|------------|------------|------------|------------|------------|------------|------------|------------|-------------|-------------|-------------|-------------|------|
| ALFA 200 CTB | | | | | | | | | | | | | | | | | | | | | | | | | | | | | | |
| ELBOWS | | | | 63 | 75 | 90 | 110 | 125 | 140 | 160 | 180 | 200 | | | | | | | | | | | | | | | | | | |
| Y - T - X | | | | 63 | 75 | 90 | 110 | 125 | 140 | 160 | | | | | | | | | | | | | | | | | | | | |
| ALFA 400 MANUAL | | | | | | | | | | | | | | | | | | | | | | | | | | | | | | |
| ELBOWS | | | | | | 90 | 110 | 125 | 140 | 160 | 180 | 200 | 225 | 250 | 280 | 315 | 355 | 400 | | | | | | | | | | | | |
| Y - T - X | | | | | | 90 | 110 | 125 | 140 | 160 | 180 | 200 | 225 | 250 | 280 | 315 | | | | | | | | | | | | | | |
| ALFA 400 EASY LIFE | | | | | | | | | | | | | | | | | | | | | | | | | | | | | | |
| ELBOWS | | | | | | 90 | 110 | 125 | 140 | 160 | 180 | 200 | 225 | 250 | 280 | 315 | 355 | 400 | | | | | | | | | | | | |
| Y - T - X | | | | | | 90 | 110 | 125 | 140 | 160 | 180 | 200 | 225 | 250 | 280 | 315 | | | | | | | | | | | | | | |
| ALFA 400 CTB | | | | | | | | | | | | | | | | | | | | | | | | | | | | | | |
| ELBOWS | | | | | | | 110 | 125 | 140 | 160 | 180 | 200 | 225 | 250 | 280 | 315 | 355 | 400 | | | | | | | | | | | | |
| Y - T - X | | | | | | | 110 | 125 | 140 | 160 | 180 | 200 | 225 | 250 | 280 | 315 | 355 | | | | | | | | | | | | | |
| ALFA 630 T | | | | | | | | | | | | | | | | | | | | | | | | | | | | | | |
| ELBOWS | | | | | | | | | | | | | 225 | 250 | 280 | 315 | 355 | 400 | 450 | 500 | 560 | 630 | | | | | | | | |
| Y - T - X | | | | | | | | | | | | | 225 | 250 | 280 | 315 | 355 | 400 | 450 | 500 | 560 | 630 | | | | | | | | |
| ALFA 1000 | | | | | | | | | | | | | | | | | | | | | | | | | | | | | | |
| ELBOWS | | | | | | | | | | | | | | | | | | 355 | 400 | 450 | 500 | 560 | 630 | 710 | 800 | 900 | 1000 | | | |
| Y - T - X | | | | | | | | | | | | | | | | | | 355 | 400 | 450 | 500 | 560 | 630 | 710 | 800 | | | | | |
| ALFA 1200 | | | | | | | | | | | | | | | | | | | | | | | | | | | | | | |
| ELBOWS | | | | | | | | | | | | | | | | | | | | | | | 630 | 710 | 800 | 900 | 1000 | 1200 | | |
| Y - T - X | | | | | | | | | | | | | | | | | | | | | | | 630 | 710 | 800 | 900 | 1000 | | | |
| ALFA 1600 | | | | | | | | | | | | | | | | | | | | | | | | | | | | | | |
| ELBOWS | | | | | | | | | | | | | | | | | | | | | | | | 710 | 800 | 900 | 1000 | 1200 | 1400 | 1600 |
| Y - T - X | | | | | | | | | | | | | | | | | | | | | | | | 710 | 800 | 900 | 1000 | 1200 | | |
| WORKING RANGE Ø mm | 32 | 40 | 50 | 63 | 75 | 90 | 110 | 125 | 140 | 160 | 180 | 200 | 225 | 250 | 280 | 315 | 355 | 400 | 450 | 500 | 560 | 630 | 710 | 800 | 900 | 1000 | 1200 | 1400 | 1600 | |

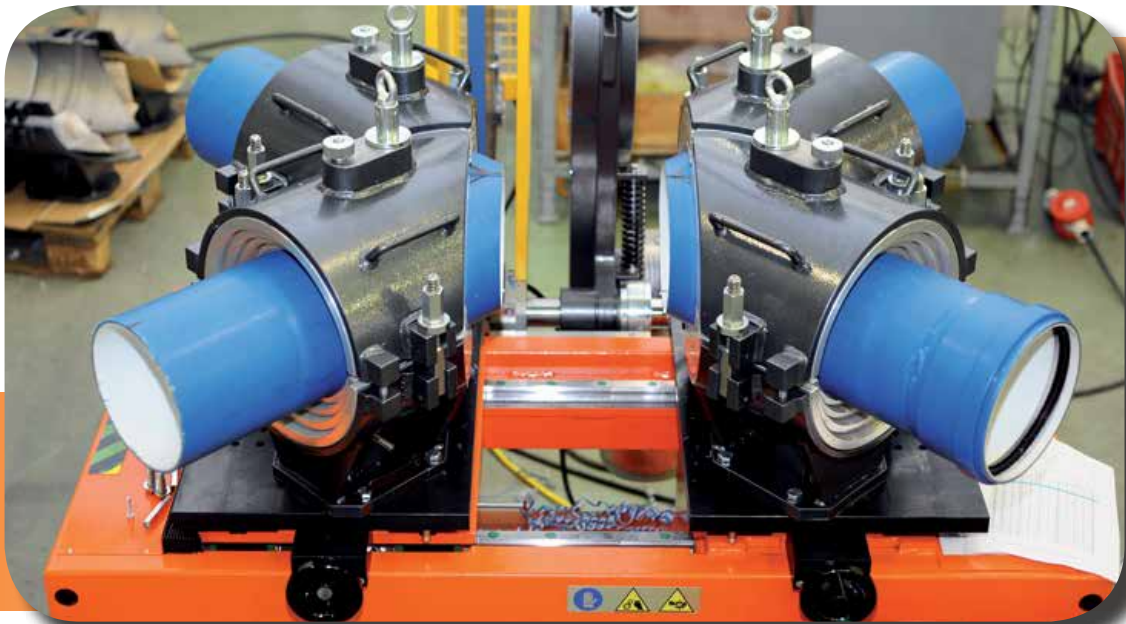

| WORKING RANGE Ø IPS | 2" | 3" | 4" | 5" | 6" | 8" | 10" | 12" | 14" | 16" | 18" | 20" | 22" | 24" | 26" | 28" | 30" | 32" | 34" | 36" | 42" | 48" | 54" | 63" | | |
|---------------------|----|----|----|----|----|----|-----|-----|-----|-----|-----|-----|-----|-----|-----|-----|-----|-----|-----|-----|-----|-----|-----|-----|-----|-----|
| ALFA 200 CTB | | | | | | | | | | | | | | | | | | | | | | | | | | |
| ELBOWS | 2" | 3" | 4" | 5" | 6" | | | | | | | | | | | | | | | | | | | | | |
| Y - T - X | 2" | 3" | 4" | 5" | | | | | | | | | | | | | | | | | | | | | | |
| ALFA 400 MANUAL | | | | | | | | | | | | | | | | | | | | | | | | | | |
| ELBOWS | | | 4" | 5" | 6" | 8" | 10" | 12" | 14" | 16" | | | | | | | | | | | | | | | | |
| Y - T - X | | | 4" | 5" | 6" | 8" | 10" | 12" | | | | | | | | | | | | | | | | | | |
| ALFA 400 EASY LIFE | | | | | | | | | | | | | | | | | | | | | | | | | | |
| ELBOWS | | | 4" | 5" | 6" | 8" | 10" | 12" | 14" | 16" | | | | | | | | | | | | | | | | |
| Y - T - X | | | 4" | 5" | 6" | 8" | 10" | 12" | | | | | | | | | | | | | | | | | | |
| ALFA 400 CTB | | | | | | | | | | | | | | | | | | | | | | | | | | |
| ELBOWS | | | 4" | 5" | 6" | 8" | 10" | 12" | 14" | 16" | | | | | | | | | | | | | | | | |
| Y - T - X | | | 4" | 5" | 6" | 8" | 10" | 12" | | | | | | | | | | | | | | | | | | |
| ALFA 630 T | | | | | | | | | | | | | | | | | | | | | | | | | | |
| ELBOWS | | | | | | 8" | 10" | 12" | 14" | 16" | 18" | 20" | 22" | 24" | | | | | | | | | | | | |
| Y - T - X | | | | | | 8" | 10" | 12" | 14" | 16" | 18" | 20" | 22" | 24" | | | | | | | | | | | | |
| ALFA 48" | | | | | | | | | | | | | | | | | | | | | | | | | | |
| ELBOWS | | | | | | | | | | | | | | | 24" | 26" | 28" | 30" | 32" | 34" | 36" | 42" | 48" | | | |
| Y - T - X | | | | | | | | | | | | | | | 24" | 26" | 28" | 30" | 32" | 34" | 36" | | | | | |
| ALFA 63" | | | | | | | | | | | | | | | | | | | | | | | | | | |
| ELBOWS | | | | | | | | | | | | | | | | | 26" | 28" | 30" | 32" | 34" | 36" | 42" | 48" | 54" | 63" |
| Y - T - X | | | | | | | | | | | | | | | | | 26" | 28" | 30" | 32" | 34" | 36" | 42" | 48" | | |
| WORKING RANGE Ø IPS | 2" | 3" | 4" | 5" | 6" | 8" | 10" | 12" | 14" | 16" | 18" | 20" | 22" | 24" | 26" | 28" | 30" | 32" | 34" | 36" | 42" | 48" | 54" | 63" | | |

| WORKING RANGE Ø DIPS | 2" | 3" | 4" | 5" | 6" | 8" | 10" | 12" | 14" | 16" | 18" | 20" | 22" | 24" |
|----------------------|----|----|----|----|----|----|-----|-----|-----|-----|-----|-----|-----|-----|
| ALFA 200 CTB | | | | | | | | | | | | | | |
| ELBOWS | | 3" | 4" | 5" | 6" | | | | | | | | | |
| Y - T - X | | 3" | 4" | | | | | | | | | | | |
| ALFA 400 MANUAL | | | | | | | | | | | | | | |
| ELBOWS | | | 4" | 5" | 6" | 8" | 10" | 12" | 14" | | | | | |
| Y - T - X | | | 4" | 5" | 6" | 8" | 10" | | | | | | | |
| ALFA 400 EASY LIFE | | | | | | | | | | | | | | |
| ELBOWS | | | 4" | 5" | 6" | 8" | 10" | 12" | 14" | | | | | |
| Y - T - X | | | 4" | 5" | 6" | 8" | 10" | | | | | | | |
| ALFA 400 CTB | | | | | | | | | | | | | | |
| ELBOWS | | | 4" | 5" | 6" | 8" | 10" | 12" | 14" | | | | | |
| Y - T - X | | | 4" | 5" | 6" | 8" | 10" | 12" | | | | | | |
| ALFA 630 T | | | | | | | | | | | | | | |
| ELBOWS | | | | | | 8" | 10" | 12" | 14" | 16" | 18" | 20" | 22" | 24" |
| Y - T - X | | | | | | 8" | 10" | 12" | 14" | 16" | 18" | 20" | 22" | 24" |
| WORKING RANGE Ø DIPS | 2" | 3" | 4" | 5" | 6" | 8" | 10" | 12" | 14" | 16" | 18" | 20" | 22" | 24" |

HOW TO FABRICATE A SPECIAL FITTING

ELBOWS

| | Cut | Welding | |
|--|-----|---------|--|
| | | | |

WYES (Y)

| | Cut | Welding 1 st stage | Welding 2 nd stage | |
|--|-----|-------------------------------|-------------------------------|--|
| | | | | |

TEES

| | Cut | Welding 1 st stage | Welding 2 nd stage | |
|--|-----|-------------------------------|-------------------------------|--|
| | | | | |

CROSSES

| | Cut | Welding 1 st stage | Welding 2 nd stage | |
|--|-----|-------------------------------|-------------------------------|--|
| | | | | |



Elbows 40 ÷ 200 mm
 2" ÷ 6" IPS; 3" ÷ 6" DIPS
 0° ÷ 45°

Wyes 63 ÷ 160 mm
 2" ÷ 6" IPS; 3" ÷ 4" DIPS
 45° ÷ 60°

Tees/Crosses
 63 ÷ 160 mm
 2" ÷ 6" IPS; 3" ÷ 4" DIPS



ALFA 200 CTB

This is a workshop welding machine designed to fabricate fittings like elbows (up to \varnothing 200 mm; 6" DIPS), tees, crosses and wyes (Y) (up to \varnothing 160 mm; 6" IPS) by joining pipe segments, with the help of special jaws. The ALFA 200 CTB can also weld special and moulded fittings such as elbows, tees and flange necks, thanks to a different type of special jaws. Composed of:

- A machine body with two carriages, one of which driven by a hydraulic system, and two lateral supports with inserts.
- A control panel that features the Easy Life system, thanks to which it is possible to carry out a whole welding cycle in a simple, intuitive and repeatable way, so that the operator's interference would be reduced to the minimum. An built-in memory allows the machine to store 4000 welding cycles (including the set diameters and SDR); possibility to pre-set 50 customized. It is possible to transfer the PDF report via USB slot.
- Heating plate with lifting sliding arm.
- An electrically controlled milling cutter for levelling the ends of the pipes and/or fittings with built-in overload cutout and safety microswitch.
- An upper cylinder, to be positioned on the jaws, for welding extra thick pipes and/or whenever it's necessary to use high pressures.

ON REQUEST

- **Elbows clamps \varnothing 200 mm**
 with lateral support
 inserts \varnothing 40 ÷ 180 mm
 \varnothing 2" ÷ 6" IPS
 \varnothing 3" ÷ 6" DIPS
- **Tees/crosses clamps \varnothing 160 mm**
 inserts \varnothing 63 ÷ 140 mm
- **Tees/crosses clamps \varnothing 6" IPS**
 inserts \varnothing 2" ÷ 5" IPS
 \varnothing 3" ÷ 4" DISP
- **Wyes clamps \varnothing 160 mm**
 inserts \varnothing 63 ÷ 140 mm
- **Wyes clamps \varnothing 6" IPS**
 inserts \varnothing 2" ÷ 5" IPS
 \varnothing 3" ÷ 4" DISP
- Right or left special clamps \varnothing 200
 inserts \varnothing 40 ÷ 180 mm

TECHNICAL FEATURES

| | |
|-----------------------------|--|
| Materials | HDPE, PP For other materials contact RITMO S.P.A. |
| Power supply | 230 V Single Phase 50/60 Hz |
| Total absorbed power | 3500 W |
| Working temperature | 165° ÷ 280° C (329° ÷ 536° F) |
| Outside temperature range | -5° ÷ 40° C (23° ÷ 104° F) |
| Weight standard composition | 250 Kg (550 lb) |
| Dimensions | 1200 x 1300 x 1530 mm 47.2" x 51.2" x 60.2" |

- Tool for flange necks
- THE INSPECTOR Data-logging and cables



ALFA 400 MANUAL

Workshop welding machine designed to fabricate fittings like elbows, tees, crosses and wyes up to \varnothing 400 mm, by joining pipe segments, with the help of special jaws.

STANDARD COMPOSITION:

- A machine body with two carriages, one of which driven by a hydraulic system, upper cylinder and tools kit
- A manual hydraulic control panel for the welding cycle
- A milling cutter for levelling the ends of the pipes and/or fittings with built-in overload cutout and safety microswitch
- A Teflon-coated heating plate, power supply 230 V or 400 V 50/60 Hz
- Right and left elbows clamps \varnothing 400 mm with steel inserts from \varnothing 90 mm to 355 mm

ON REQUEST

- Elbows clamps \varnothing 16" IPS;
inserts \varnothing 4" \div 14" IPS; \varnothing 4" \div 14" DIPS
- Tees/crosses clamps \varnothing 315 mm; inserts \varnothing 90 \div \varnothing 280 mm
- Tees/crosses clamps \varnothing 12" IPS;
inserts \varnothing 4" \div 10" IPS; \varnothing 4" \div 10" DIPS
- Wyes clamps \varnothing 315 mm; inserts \varnothing 90 \div \varnothing 280 mm
- Wyes clamps \varnothing 12" IPS;
inserts \varnothing 4" \div 10" IPS; \varnothing 4" \div 10" DIPS
- Right or left special clamps \varnothing 400; inserts \varnothing 110 \div \varnothing 355 mm
- Tool for flange necks
- Facer disk for PVC
- THE INSPECTOR Data-logging and cables

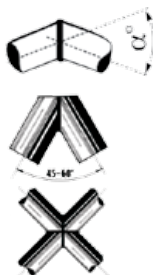

Elbows 90 \div 400 mm
4" \div 16" IPS; 4" \div 14" DIPS
0° \div 45°

Wyes 90 \div 315 mm
4" \div 12" IPS; 4" \div 10" DIPS
45° \div 60°

Tees/Crosses
90 \div 315 mm
4" \div 12" IPS; 4" \div 10" DIPS

TECHNICAL FEATURES

| | |
|-----------------------------|---|
| Materials | HDPE, PP For other materials contact RITMO S.P.A. |
| Power supply | 230 V Single Phase 50/60 Hz 400 V Three Phase 50/60 Hz |
| Total absorbed power | 7400 W |
| Working temperature | 180° \div 280° C (356° \div 536° F) |
| Outside temperature range | -5° \div 40° C (23° \div 104° F) |
| Weight standard composition | 647 Kg (1426 lb) |
| Dimensions | 1490 x 2020 x 1700 mm 58.6" x 79.5" x 67" |

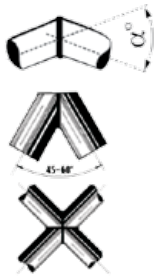

Elbows 90 ÷ 400 mm
 4" ÷ 16" IPS; 4" ÷ 14" DIPS
 0° ÷ 45°

Wyes 90 ÷ 315 mm
 4" ÷ 12" IPS; 4" ÷ 10" DIPS
 45° ÷ 60°

Tees/Crosses
 90 ÷ 315 mm
 4" ÷ 12" IPS; 4" ÷ 10" DIPS



ALFA 400 EASY LIFE

This is a workshop welding machine designed to fabricate fittings like elbows (up to \varnothing 400 mm; 16" IPS), wyes (Y), tees and crosses (up to \varnothing 315 mm; 12" IPS) by joining pipe segments, with the help of special jaws.

The ALFA 400 EASY LIFE can also weld special and moulded fittings such as elbows, tees and flange necks, thanks to a different type of special jaws. Composed of:

A machine body with two carriages, one of which driven by a hydraulic system. A control panel that features the CNC system, thanks to this would eliminate any risk of error due to the operator. The CNC incorporates a data-logging that can store up to 4000 cycles; possibility to pre-set 50 customized. It is possible to download the PDF report via USB slot.

A printer can be connected to the serial port, to get a welding report at the end of each welding cycle. A heating plate featuring a new horizontal sliding system, automatically operated, which enables a fast side-sliding of the plate during the exchange period. The whole process is carried out with no need of disconnecting the upper cylinder, whenever it is in use. A milling cutter for levelling the ends of pipes and/or fittings that slides on recirculating ball slideways, with an electronic device for a soft start. An upper cylinder, to be positioned on the jaws, for welding extra thick pipes and/or whenever it's necessary to use high pressures. Available in 230 V and 400 V.

STANDARD COMPOSITION

Welding machine complete with:

- control panel
- heating plate
- milling cutter
- upper cylinder and tools kit
- elbows clamps \varnothing 400 mm;
 inserts \varnothing 90 ÷ 355 mm

ON REQUEST

- **Elbows clamps \varnothing 16" IPS;**
 inserts \varnothing 4" ÷ 14" IPS; \varnothing 4" ÷ 14" DIPS
- **Tees/crosses clamps \varnothing 315 mm;**
 inserts \varnothing 90 ÷ 280 mm
- **Tees/crosses clamps \varnothing 12" IPS;**
 inserts \varnothing 4" ÷ 10" IPS; \varnothing 4" ÷ 10" DIPS
- **Wyes clamps \varnothing 315 mm;**
 inserts \varnothing 90 ÷ 280 mm
- **Wyes clamps \varnothing 12" IPS;**
 inserts \varnothing 4" ÷ 10" IPS; \varnothing 4" ÷ 10" DIPS
- Right or left special clamps \varnothing 400;
 inserts from \varnothing 110 to \varnothing 355 mm
- Tool for flange necks
- Facer disk for PVC

TECHNICAL FEATURES

| | |
|---------------------------|---|
| Materials | HDPE, PP For other materials contact RITMO S.P.A. |
| Power supply | 230 V Single Phase 50/60 Hz 400 V Three Phase 50/60 Hz |
| Total absorbed power | 7360 W |
| Working temperature | 180° ÷ 280° C (356° ÷ 536° F) |
| Outside temperature range | -5° ÷ 40° C (23° ÷ 104° F) |
| Weight machine body | 647 Kg (1426 lb) |
| Dimensions | 1490 x 2020 x 1700 mm 58.6" x 79.5" x 67" |



Special clamps
 \varnothing 400 mm

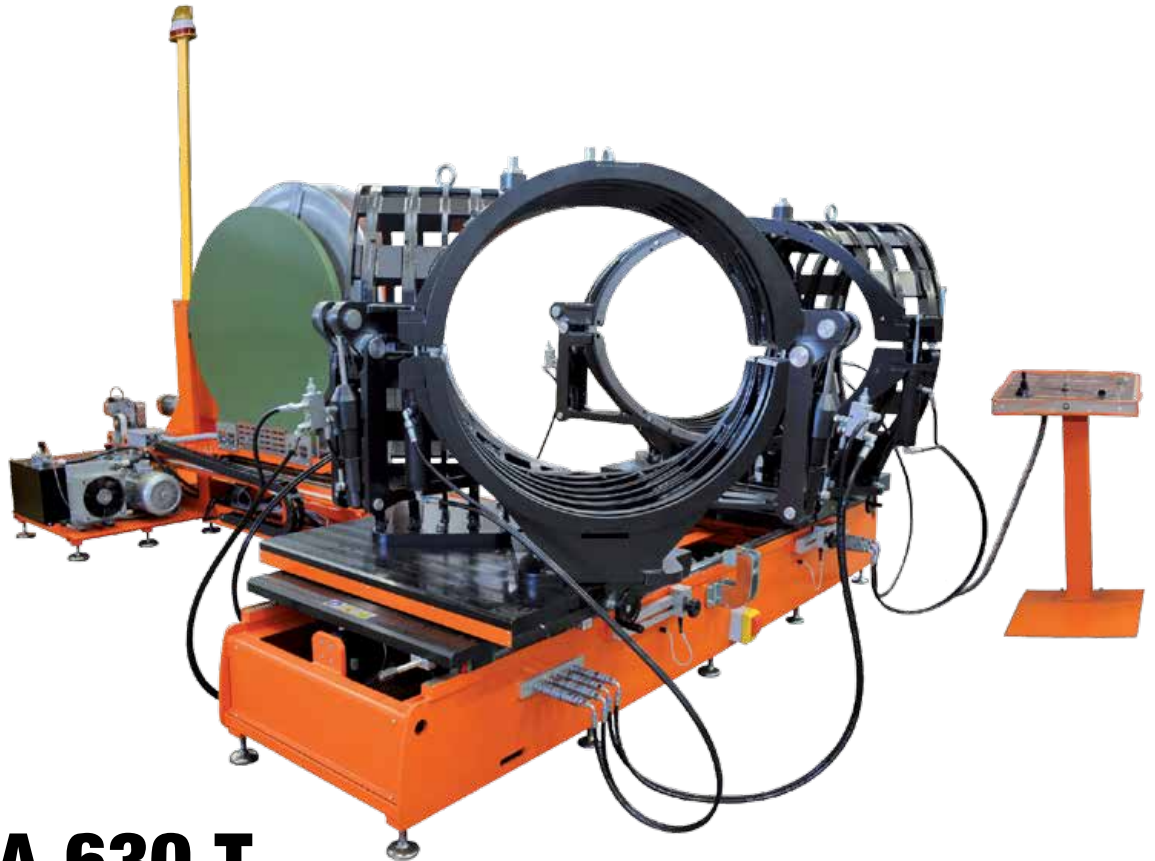

ALFA 630 T

Workshop welding machine designed to fabricate fittings like elbows, wyes, tees and crosses (up to \varnothing 630 mm or 24" DIPS). All jaws movements are electro-hydraulically operated, both the open/close movement and the blocking mechanism.

Composed of:

- A machine body with two hydraulically controlled carriages.
- A control panel that features the CNC system, thanks to this would eliminate any risk of error due to the operator. The CNC incorporates a data-logging that can store up to 4000 cycles. It is possible to download the PDF report via USB slot; possibility to pre-set 20 customized
- A Teflon-coated heating plate with electrical movement (in/out) on spherical bearings guides.
- A milling cutter with electrical movement (in/out) on spherical bearings guides, operated by an electrical engine.
- An upper cylinder, to be positioned on the jaws, for welding extra thick pipes and/or whenever it is necessary to apply high pressures.

STANDARD COMPOSITION

- Welding machine complete with control panel
- Heating plate, milling cutter
- Elbows jaws \varnothing 24" DIPS with inserts \varnothing 315 ÷ 630 mm
- Upper cylinder and tool kit

ON REQUEST

- **Elbows jaws \varnothing 24" DIPS** inserts \varnothing 225 ÷ 280 mm
inserts \varnothing 8" ÷ 24" IPS; \varnothing 8" ÷ 24" DIPS
- **Wyes jaws \varnothing 24" DIPS** inserts \varnothing 225 ÷ 630 mm
inserts \varnothing 8" ÷ 24" IPS; \varnothing 8" ÷ 20" DIPS
- **Tees/crosses jaws \varnothing 24" DIPS** inserts \varnothing 225 ÷ 630 mm
inserts \varnothing 8" ÷ 24" IPS; \varnothing 8" ÷ 20" DIPS
- Special milling cutter plates and blades for PVC



TECHNICAL FEATURES

PLUS

**CNC
WELDING SYSTEM**

HYDRAULIC CLAMPS

DATA-LOGGING

USB PORT

| | |
|---------------------------|--|
| Materials | HDPE, PP For other materials contact RITMO S.P.A. |
| Power supply | 400 V 3F+N+PE 50/60 HZ |
| Total absorbed power | 30000 W |
| Working temperature | 180° ÷ 280° C (356° ÷ 536° F) |
| Outside temperature range | up to 40° C (104° F) |
| Angle reading sensivity | ± 1° |
| Dimensions | 2940 x 4000 x 2000 mm 115.7" x 157.5" x 78.7" |
| Weight | 3325 Kg (7330 lb) |

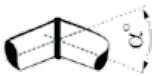

Elbows 225* ÷ 630 mm
8" ÷ 24" IPS; 8" ÷ 24" DIPS
0° ÷ 60°



Wyes 225* ÷ 630 mm
8" ÷ 24" IPS; 8" ÷ 24" DIPS
45° ÷ 60°



Tees/Crosses
225* ÷ 630 mm
8" ÷ 24" IPS; 8" ÷ 24" DIPS



* 225 ÷ 280 mm on request
standard composition 315 ÷ 630 mm

Norway





watch the video

ALFA 1000

CNC workshop welding machine designed to fabricate fittings like elbows, wyes, tees and crosses. The jaws movements are electro-hydraulically operated, both the open/close movement and the blocking mechanism.

Composed of:

- A machine body with two hydraulically controlled carriages.
- A control panel that features the CNC system, thanks to this would eliminate any risk of error due to the operator. The CNC incorporates a datalogging that can store up to 4000 cycles. It is possible to download the PDF report via USB slot; possibility to pre-set 20 customized.
- A Teflon-coated heating plate with electrical movement (in/out) on spherical bearings guides.
- A milling cutter with electrical movement (in/out) on spherical bearings guides, operated by an electrical engine.
- An upper cylinder, to be positioned on the jaws, for welding extra thick pipes and/or whenever it is necessary to apply high pressures.

STANDARD COMPOSITION

- Welding machine complete with control panel
- Heating plate, milling cutter
- Upper cylinder and tool kit
- Elbows jaws complete with inserts from \varnothing 355 to \varnothing 900 mm

ON REQUEST

- Wyes jaws \varnothing 800 complete with inserts from \varnothing 355 to \varnothing 710 mm
- Tees/crosses jaws \varnothing 800 complete with inserts from \varnothing 355 to 710 mm



TECHNICAL FEATURES

PLUS

**CNC
WELDING SYSTEM**

HYDRAULIC CLAMPS

DATA-LOGGING

USB PORT

| | |
|---------------------------|--|
| Materials | HDPE, PP For other materials contact RITMO S.P.A. |
| Power supply | 400 V 3F+N+PE 50/60 HZ |
| Total absorbed power | 38000 W |
| Working temperature | 180° ÷ 280° C (356° ÷ 536° F) |
| Outside temperature range | up to 40° C (104° F) |
| Angle reading sensivity | ± 1° |
| Dimensions | 2980 x 4560 x 3060 mm 117.3" x 179.5" x 120.4" |
| Weight | 3130 Kg (6900 lb) |

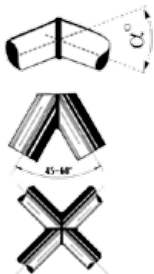

Elbows 355 ÷ 1000 mm
0° ÷ 60°

Wyes 355 ÷ 800 mm
45° ÷ 60°

Tees/Crosses
355 ÷ 800 mm



Egypt



ALFA 1200

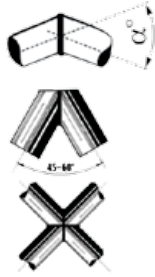

Elbows 630 ÷ 1200 mm
0° ÷ 60°

Wyes 630 ÷ 1000 mm
45° ÷ 60°

Tees/Crosses
630 ÷ 1000 mm

Workshop welding machine designed to fabricate fittings like elbows, wyes, tees and crosses up to Ø 1200 mm. The ALFA 1200 welding plastic materials such as: HDPE, PP.*

STANDARD COMPOSITION

- A machine body with two hydraulically controlled carriages and hydraulic clamps.
- A control panel that features the CNC system, thanks to this would eliminate any risk of error due to the operator. The CNC incorporates a data-logging that can store up to 4000 cycles. It is possible to download the PDF report via USB slot; possibility to pre-set 20 customized.
- A milling cutter with electrical movement (in/out)
- A Teflon-coated heating plate with electrical movement (in/out)

ALFA 48" IPS

Workshop welding machine designed to fabricate fittings like elbows, wyes, tees and crosses up to Ø 48" IPS mm. The ALFA 48" IPS welding plastic materials such as: HDPE, PP.*

STANDARD COMPOSITION

- A machine body with two hydraulically controlled carriages and hydraulic clamps.
- A control panel that features the CNC system, thanks to this would eliminate any risk of error due to the operator. The CNC incorporates a data-logging that can store up to 4000 cycles. It is possible to download the PDF report via USB slot; possibility to pre-set 20 customized.
- A milling cutter with electrical movement (in/out)
- A Teflon-coated heating plate with electrical movement (in/out)



TECHNICAL FEATURES

| | |
|---------------------------|--|
| Materials | HDPE, PP For other materials contact RITMO S.P.A. |
| Power supply | 400 V Three Phase 50/60 Hz |
| Total absorbed power | 46000 W |
| Working temperature | 180° ÷ 280° C (356° ÷ 536° F) |
| Outside temperature range | -5° ÷ 40° C (23° ÷ 104° F) |
| Weight machine body | 6120 Kg (13500 lb) |
| Dimensions | 4100 x 6000 x 3060 mm 161.4" x 236" x 120.5" |



Elbows 24" IPS ÷ 48" IPS
0° ÷ 60°

Wyes 24" IPS ÷ 36" IPS
45° ÷ 60°

Tees/Crosses
24" IPS ÷ 36" IPS



watch the video



Elbows 710 ÷ 1600 mm
0° ÷ 60°



Wyes 710 ÷ 1200 mm
45° ÷ 60°



Tees/Crosses
710 ÷ 1200 mm



ALFA 1600

Workshop welding machine designed to fabricate fittings like elbows, wyes, tees and crosses up to \varnothing 1600 mm. The ALFA 1600 welding plastic materials such as: HDPE, PP.*

STANDARD COMPOSITION

Composed of:

- A machine body with two hydraulically controlled carriages and hydraulic clamps.
- A control panel that features the CNC system, thanks to this would eliminate any risk of error due to the operator. The CNC incorporates a data-logging that can store up to 4000 cycles. It is possible to download the PDF report via USB slot; possibility to pre-set 20 customized.
- A milling cutter with electrical movement (in/out)
- A Teflon-coated heating plate with electrical movement (in/out)
- Elbows jaws \varnothing 1600 mm complete with inserts from \varnothing 710 to \varnothing 1400 mm

ON REQUEST

- Tees/crosses clamps \varnothing 1200 mm;
inserts \varnothing 710 ÷ 1000 mm
- Wyes clamps \varnothing 1200 mm;
inserts \varnothing 710 ÷ 1000 mm



TECHNICAL FEATURES

| | |
|---------------------------|--|
| Materials | HDPE, PP For other materials contact RITMO S.P.A. |
| Power supply | 400 V Three Phase 50/60 Hz |
| Total absorbed power | 92300 W |
| Working temperature | 180° ÷ 280° C (356° ÷ 536° F) |
| Outside temperature range | -5° ÷ 40° C (23° ÷ 104° F) |
| Weight machine body | 8800 Kg (19400 lb) |
| Dimensions | 7369 x 4487 x 2844 mm 290" x 177" x 112" |



OMEGA 400 - 250

OMEGA 400 - 250 is a fusion welding machine for in shop use for the manufacturing of special parts, such as reducing branches (Tees, Crosses) .

STANDARD COMPOSITION

- Machine body with manual carriage for socket centring
- Hydraulic jaws for locking pipe & branches
- Side support for branches
- Quick release inserts
- EASY LIFE control panel: allows a simple-easy-repeatable welding cycle, reducing the necessity of operator's intervention.
- A built-in memory records 4000 welding cycles; the data will be available through PDF reports, downloadable in a USB pen drive. Possibility to pre-set 20 customized.
- Hydraulic movement of heating plate that can host male/female sockets with heating plate detaching device
- Reduced Tee Driller (on request)

INTEGRATIVE SYSTEMS

RADIUS 40-315 machine for radial cutting

Reduced Tee Driller



FEASIBLE BRANCHES

| Ø mm MAIN PIPE | Ø mm BRANCH PIPE | | | | | | | | | | | |
|----------------|------------------|----|----|----|-----|-----|-----|-----|-----|-----|-----|-----|
| | 50 | 63 | 75 | 90 | 110 | 125 | 140 | 160 | 180 | 200 | 225 | 250 |
| 90 | * | * | | | | | | | | | | |
| 110 | * | * | * | | | | | | | | | |
| 125 | * | * | * | * | | | | | | | | |
| 140 | * | * | * | * | * | | | | | | | |
| 160 | * | * | * | * | * | * | | | | | | |
| 180 | * | * | * | * | * | * | * | | | | | |
| 200 | * | * | * | * | * | * | * | * | | | | |
| 225 | * | * | * | * | * | * | * | * | * | | | |
| 250 | * | * | * | * | * | * | * | * | * | * | | |
| 280 | * | * | * | * | * | * | * | * | * | * | * | |
| 315 | * | * | * | * | * | * | * | * | * | * | * | * |
| 355 | * | * | * | * | * | * | * | * | * | * | * | * |
| 400 | * | * | * | * | * | * | * | * | * | * | * | * |

TECHNICAL FEATURES

| | |
|---------------------------|--|
| Materials | HDPE, PP |
| Power supply | 230 Vac 50/60 Hz |
| Total absorbed power | 6500 W |
| Working temperature | 180° ÷ 280° C (356° ÷ 536° F) |
| Weight: machine | 735 Kg (1620 lb) |
| Weight: control panel | 55 Kg (124 lb) |
| Dimensions: machine | 1680 x 1600 x 1690 mm; 66.1" x 63" x 66.5" |
| Dimensions: control panel | 600 x 600 x 1150 mm; 23.6" x 23.6" x 45.2" |



OMEGA 630 - 250

OMEGA 630 - 250 (24" IPS - 12" IPS) is a fusion welding machine for in shop use for the manufacturing of special parts, such as reducing branches (Tees, Crosses).

STANDARD COMPOSITION

- Machine body with manual carriage for socket centring
- Hydraulic jaws for locking pipe & branches
- Side support for branches
- Quick release inserts
- EASY LIFE control panel: allows a simple-easy-repeatable welding cycle, reducing the necessity of operator's intervention
- A built-in memory records 4000 welding cycles; The data will be available through PDF reports, downloadable in a USB pen drive. Possibility to pre-set 20 customized.
- Hydraulic movement of heating plate that can host male/female sockets with heating plate detaching device
- Reduced Tee Driller (on request)

INTEGRATIVE SYSTEMS

RADIUS 40-315 machine for radial cutting



FEASIBLE BRANCHES

| | Ø mm BRANCH PIPE | | | | | | | | | | | | |
|----------------|------------------|----|----|----|-----|-----|-----|-----|-----|-----|-----|-----|---|
| | 50 | 63 | 75 | 90 | 110 | 125 | 140 | 160 | 180 | 200 | 225 | 250 | |
| Ø mm MAIN PIPE | 90 | • | • | | | | | | | | | | |
| 110 | • | • | • | | | | | | | | | | |
| 125 | • | • | • | • | | | | | | | | | |
| 140 | • | • | • | • | • | | | | | | | | |
| 160 | • | • | • | • | • | • | | | | | | | |
| 180 | • | • | • | • | • | • | • | | | | | | |
| 200 | • | • | • | • | • | • | • | • | | | | | |
| 225 | • | • | • | • | • | • | • | • | • | | | | |
| 250 | • | • | • | • | • | • | • | • | • | • | | | |
| 280 | • | • | • | • | • | • | • | • | • | • | • | | |
| 315 | • | • | • | • | • | • | • | • | • | • | • | • | |
| 355 | • | • | • | • | • | • | • | • | • | • | • | • | • |
| 400 | • | • | • | • | • | • | • | • | • | • | • | • | • |
| 450 | • | • | • | • | • | • | • | • | • | • | • | • | • |
| 500 | • | • | • | • | • | • | • | • | • | • | • | • | • |
| 560 | • | • | • | • | • | • | • | • | • | • | • | • | • |
| 630 | • | • | • | • | • | • | • | • | • | • | • | • | • |

FEASIBLE BRANCHES

| | Ø IPS BRANCH PIPE | | | | | | | | | | | | |
|-----------------|-------------------|---|----|---|---|---|---|---|----|----|---|---|---|
| | 1½ | 2 | 2½ | 3 | 4 | 5 | 6 | 8 | 10 | 12 | | | |
| Ø IPS MAIN PIPE | 3 | • | • | | | | | | | | | | |
| 4 | • | • | • | | | | | | | | | | |
| 5 | • | • | • | • | | | | | | | | | |
| 6 | • | • | • | • | • | | | | | | | | |
| 8 | • | • | • | • | • | • | | | | | | | |
| 10 | • | • | • | • | • | • | • | | | | | | |
| 12 | • | • | • | • | • | • | • | • | | | | | |
| 14 | • | • | • | • | • | • | • | • | • | | | | |
| 16 | • | • | • | • | • | • | • | • | • | • | | | |
| 18 | • | • | • | • | • | • | • | • | • | • | • | | |
| 20 | • | • | • | • | • | • | • | • | • | • | • | • | |
| 22 | • | • | • | • | • | • | • | • | • | • | • | • | • |
| 24 | • | • | • | • | • | • | • | • | • | • | • | • | • |

TECHNICAL FEATURES

Reduced Tee Driller



| | |
|---------------------------|--|
| Materials | HDPE, PP |
| Power supply | 230 Vac 50/60 Hz |
| Total absorbed power | 6500 W |
| Working temperature | 180° ÷ 280° C (356° ÷ 536° F) |
| Weight: machine | 758 Kg (1671 lb) |
| Weight: control panel | 55 Kg (124 lb) |
| Dimensions: machine | 1680 x 1600 x 1690 mm; 66.1" x 63" x 66.5" |
| Dimensions: control panel | 600 x 600 x 1150 mm; 23.6" x 23.6" x 45.2" |



RADIUS 40 - 315

RADIUS 40-315 is designed to perform saddle cuts on plastic pipes made of HDPE, PP, PVC.

The saw performs precise radial cuts, and thanks to a trolley that slide gradually on a scaled instrument, allows a fast configuration of the cutting radius. Even the pipe support can slide and block small pieces of pipes down to 15 cm length (6"). The saw rotation during cutting is executed manually and in complete safe conditions since the control panel and its handles are located behind the machine away from the cutting area.

This machine is not suitable to cut different materials from those specified above, including composite pipes that may contain other substances (polymers, metals, alloys, etc.).

STANDARD COMPOSITION

- Machine body with control panel and saw

INTEGRATIVE SYSTEMS for
OMEGA 630-250 and OMEGA 400-250



TECHNICAL FEATURES

| | |
|------------------------|--|
| Materials | HDPE, PP, PVC |
| Branch pipe OD | 40 ÷ 323 (1.6" x 12.7") |
| Main pipe OD | Up to 630 mm (24.8") |
| Shortest branch length | 15 cm (6") |
| Power supply | 110 Vac Single Phase 60 Hz 230 Vac Single Phase 50 Hz |
| Total absorbed power | 1100 W |
| Weight | 425 Kg (937 lb) |
| Dimensions | 1000 x 1566 x 1642 mm 39.4" x 61.5" x 64.6" |

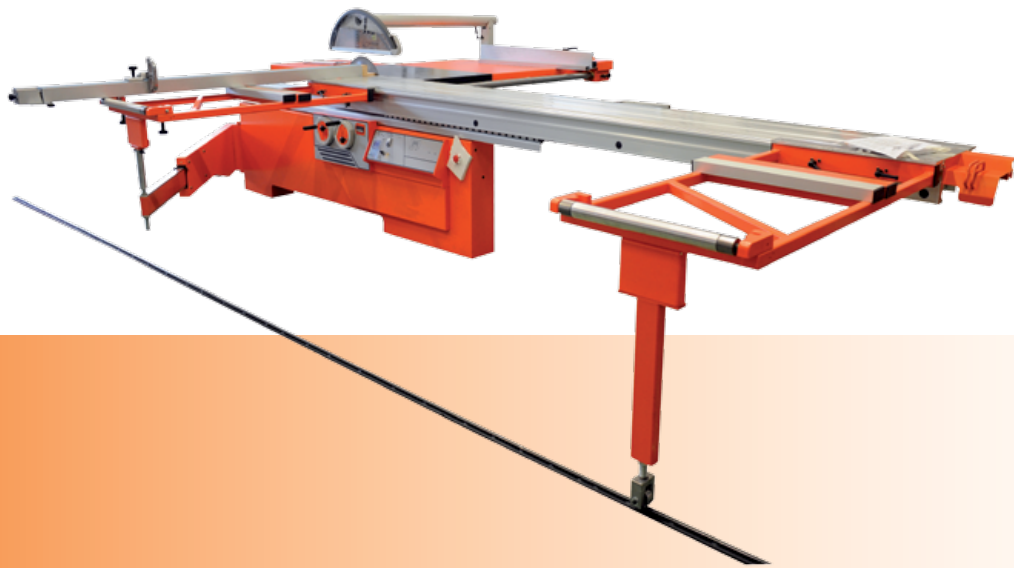

POLYCUT 4000

Polycut 4000 is a professional saw designed to cut plastic sheets such as HDPE, PP, PVC.

This machine has been specifically designed to work homogeneous plastic sheets. The following cutting operations can be carried out:

- Longitudinal cutting of not-machined or semi-machined parts;
- Parallel cutting of panels of various sizes;
- Squaring of panels of all types and various dimensions;
- Fine groovings
- Shearing;

Materials other than homogeneous plastic sheets are not suitable to this machine.

INTEGRATIVE SYSTEMS for
POLYFUSION Line



TECHNICAL FEATURES

| | |
|---------------------------|-------------------------------|
| Materials | HDPE, PP, PVC |
| Blade tilting | 0° - 45° |
| 3 Saw blade speed | rpm 2800/4000/5600 |
| Power supply | 400 Vac Three Phase 50 Hz |
| Power motor saw | 4 kW |
| Weight | 740 Kg (1632 lb) |
| Dimensions of carriage | 3800 x 300 mm; 149.6" x 11.8" |
| Dimensions of saw bench | 1100 x 650 mm; 43.3" x 25.6" |
| Squaring frame dimensions | 1400 x 640 mm; 55.1" x 25.2" |



SIGMA 400 PRO

SIGMA 400 PRO is electric workshop band saw machine for plastic pipes HDPE, PP, PVDF, PVC. The SIGMA PRO were specially designed to make angular cut, featuring a wide range of angles (from - 30° to 67,5°). They're the ideal equipment to match Alfa fittings fabrication machines. Both the preparation and cutting phases are extremely simple and safe to perform.

The machines is provided with special spherical bearings guides where the machine body can easily move sideward. The equipment includes a control panel, located at a safety distance from the cutting area, where the operator can control the manual movement of the arch saw (IN/OUT) and also adjust and regulate the cutting speed.

Special auxiliary devices can relieve the stress on the blade and help reducing the ordinary technical maintenance.

STANDARD COMPOSITION

- Auxiliary bench for cutting tees

ON REQUEST

- Pipe supporting table
- Kit for PP pipes with glass fiber



TECHNICAL FEATURES

| | |
|----------------------|---|
| Working range | 60 ÷ 450 mm; 2" IPS ÷ 18" IPS |
| Materials | HDPE, PP, PVDF, PVC For other materials contact RITMO S.P.A. |
| Power supply | 400 V 3F+N+PE 50/60 HZ |
| Total absorbed power | 860 W |
| Weight | 330 Kg (727.5 lb) |
| Dimensions | 2980 x 2650 x 2290 mm 117.3" x 104.3" x 90.2" |

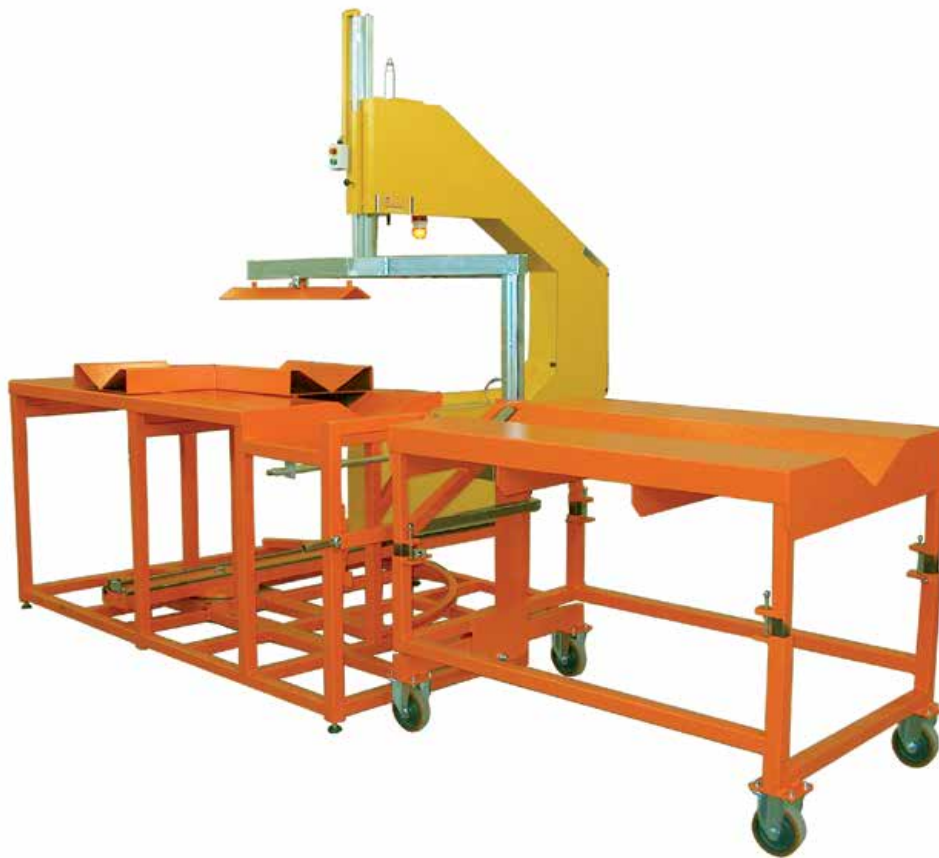

SIGMA 630 PRO

SIGMA 630 PRO is electric workshop band saw machine for plastic pipes HDPE, PP, PVDF, PVC. The SIGMA PRO were specially designed to make angular cut, featuring a wide range of angles (from - 30° to 67,5°). They're the ideal equipment to match Alfa fittings fabrication machines. Both the preparation and cutting phases are extremely simple and safe to perform.

The machines is provided with special spherical bearings guides where the machine body can easily move sideward. The equipment includes a control panel, located at a safety distance from the cutting area, where the operator can control the automatic movement of the arch saw (IN/OUT) and also adjust and regulate the cutting speed.

Special auxiliary devices can relieve the stress on the blade and help reducing the ordinary technical maintenance.

STANDARD COMPOSITION

- Auxiliary bench for cutting tees

ON REQUEST

- Pipe supporting table
- Scraps suction device
- Kit for PP pipes with glass fibre



TECHNICAL FEATURES

| | |
|----------------------|---|
| Working range | 90 ÷ 655 mm; 3" IPS ÷ 24" DIPS |
| Materials | HDPE, PP, PVDF, PVC For other materials contact RITMO S.P.A. |
| Power supply | 400 V 3F+N+PE 50/60 HZ |
| Total absorbed power | 2200 W |
| Weight | 925 Kg (2040 lb) |
| Dimensions | 4340 x 3460 x 2650 mm 170.9" x 136.2" x 104.3" |

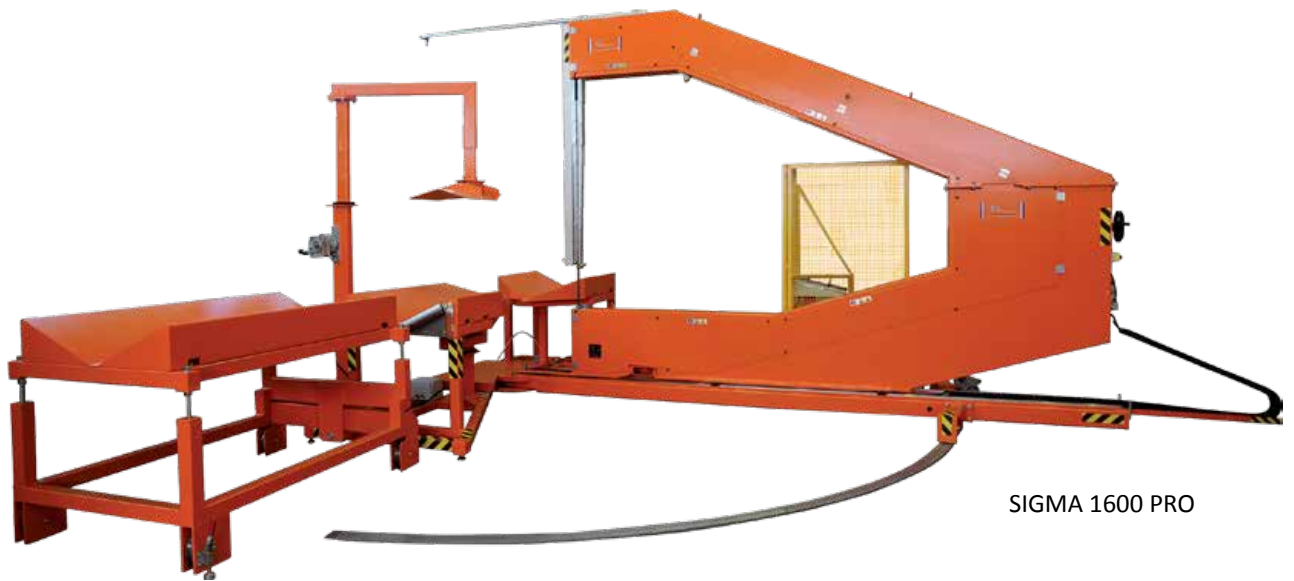

SIGMA 1600 PRO

SIGMA 1200 PRO - SIGMA 1600 PRO

SIGMA 1200 PRO and SIGMA 1600 PRO are electric workshop band saw machines, for plastic pipes up to OD 1290 mm (48 " DIPS) and OD 1702 mm (67"). They're the ideal equipment to match Alfa fittings fabrication machines. Both the preparation and cutting phases are extremely simple and safe to perform.

SIGMA 1200 and 1600 were specially designed to perform easy cuts with a wide range of angles (from - 45° to 67,5°). Thanks to a PLC system, the operator can input the exact cutting angles with the highest precision. Composed of:

- Pipe housing bench, a blade-housing arm (belt type), moving on a spherical bearings guide, performing settable advancing speed. It can rotate on an arc system, and perform a wide range of share angles.
- A continuous control blade guide telescopic system, to reduce to the minimum the blade vibration, regardless of the diameter and/or thickness of the pipe being cut. Provided with a laser-beam pointing system to localize the cutting area.
- A safety pilot cabin, where the control panel is located. It is protected by guards for greater operator's safety.
- An easy-to-use control panel, featuring a simplified graphics display, where the inclination degree of the cutting arc is displayed.

STANDARD COMPOSITION

- Band saw machine complete of an auxiliary bench to cut welded pipe sector (for Tees), and support kit for the pipe sectors (to prevent them from being damaged)

ON REQUEST

- Scraps suction device



TECHNICAL FEATURES



watch the video

| | SIGMA 1200 PRO | SIGMA 1600 PRO |
|----------------------|---|---|
| Working range OD | 280 ÷ 1290 mm; 10" IPS ÷ 48" DIPS OD contact RITMO S.P.A. | 200 ÷ 1702 mm; 8" IPS ÷ 67" OD contact RITMO S.P.A. |
| Materials | HDPE, PP, PVDF, PVC For other materials contact RITMO S.P.A. | HDPE, PP, PVDF, PVC For other materials contact RITMO S.P.A. |
| Power supply | 400 V 3F+N+PE 50/60 HZ | 400 V 3F+N+PE 50/60 HZ |
| Total absorbed power | 4600 W | 4600 W |
| Weight | 4380 Kg (9656 lb) | 4690 Kg (10340 lb) |
| Dimensions | 7100 x 9200 x 4500 mm 279,5" x 362" x 177.2" | 8600 x 11800 x 5500 mm 338,5" x 464,6" x 216.5" |



SIGMA 1200 PRO



PLASTIC FABRICATION



| * OUTPUT: Kg / h - lb / h | 2 Kg / h 4.4 lb / h | 3 Kg / h 6.6 lb / h | 4 Kg / h 8.8 lb / h | 5 Kg / h 11.2 lb / h | > 6 Kg / h 13.6 lb / h |
|---------------------------|------------------------|------------------------|------------------------|-------------------------|---------------------------|
| K-SB 20 | • | | | | |
| K-SB 30 | • | • | | | |
| K-SB 40 | • | • | • | | |
| K-SB 50 | • | • | • | • | |
| K-SB 60 | • | • | • | • | • |

* The maximum extruded capacity varies depending on the material

CUSTOMIZED PLASTIC FABRICATION USING THE STARGUN

STARGUN is the line of handy and easy to use extruder welders. All models distinguish for being light, compact and very smooth during the welding phase. The entire line is supported by a series of interchangeable Teflon® shoes which allow the STARGUN to adapt to every kind of welding situation: from plane sheets to oblique angles. Thanks to their versatility they are able to weld different types of fabrications like: containing tanks, fume treatment towers, scrubbers, chemical hoods, aspiration systems, and for joining linings and geo-textiles.

In the chart below find the main characteristics that make of the STARGUN a unique instrument.

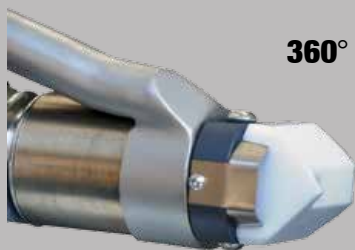
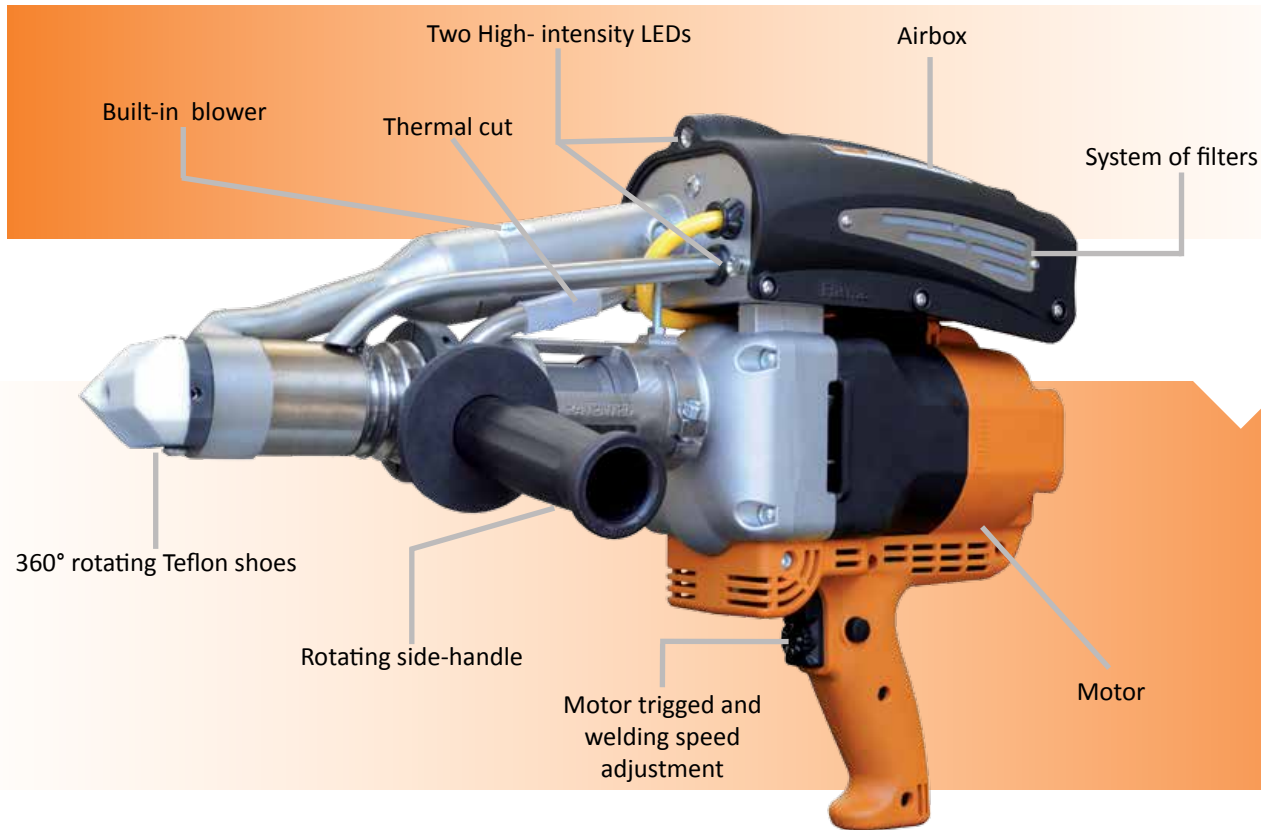

360° PRE-HEATING

Standard with model:
K-SB 20
K-SB 30
K-SB 40



90°



V Flat



360° Pre-Heating for rotating shoes

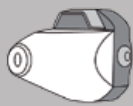

Conical



Geotextile



FIXED LATERAL PRE-HEATING

Standard with model:
K-SB 50
K-SB 60



Fixed Lateral Pre-Heating

+



Nozzle

Optional for model:
K-SB 30
K-SB 40



90°



V Flat

K-SB 20

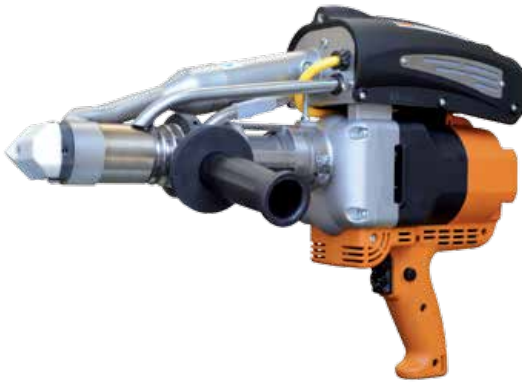

K-SB 20 is a compact and ergonomic extruder equipped with a power control device and the safety system "motor block" that doesn't allow the machine to start before it reaches the right temperature. The extruder has an innovative universal feeding system that makes possible to use the machine with different diameters of wire.

- Backlight display
- Two high-brightness LEDs for welding area
- Power regulator - welding speed adjustment;
- Security system "motor block / cold start"
- Independent blower
- Thermoregulator double electronic T ° control: for blower and extrusion
- Orientable handle
- 360° orientable and replaceable welding shoes

Standard equipment:

K-SB 20 360° rotating teflon shoes, transport case and extruder support;

- Teflon shoe 86777821 90° - a 7 mm 360° rotating shoe
- Teflon shoe 86777830 V Flat - 10/12 mm 360° rotating shoe

ON REQUEST

Teflon shoes

| | |
|----------------------|--|
| Materials | HDPE, PP, PVDF |
| Rod | Ø 3 - 4 mm; 1/8" - 5/32" |
| Sheets | 1,5 ÷ 20 mm; 1/16" ÷ 0.8" |
| *Output up to | 2 Kg/h HDPE rod Ø 4 mm; 5/32" |
| Dimension | 450 x 310 x 100 mm; 17.7" x 12.2" x 3.9" |
| Power supply | 230 Vac 50/60 Hz |
| Total absorbed power | 3100 W |
| Weight | 6.9 Kg (15.2 lb) |

* The maximum extruded capacity varies depending on the material

WELDING SHOES K-SB 20



90° - WELD

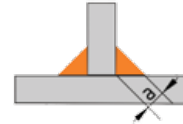

360° Rotating Shoes

| ACCORDING TO DVS STANDARD | | |
|---------------------------|------------------|----------|
| 360° Rotating Shoes | sheets thickness | Article |
| 90° - a 4.2 mm | 6 mm | 86777819 |
| 90° - a 5.6 mm | 8 mm | 86777820 |
| 90° - a 7 mm | 10 mm | 86777821 |
| 90° - a 8,4 mm | 12 mm | 86777822 |
| 90° - a 10,5 mm | 15 mm | 86777823 |
| 90° - a 14 mm | 20 mm | 86777824 |



V - WELD

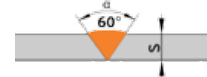

X - WELD

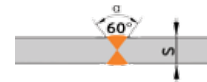

360° Rotating Shoes

| ACCORDING TO DVS STANDARD | | | |
|---------------------------|------------|------------|----------|
| 360° Rotating Shoes | V weld "S" | X weld "S" | Article |
| V Flat - 8 | 8 mm | 16 mm | 86777829 |
| V Flat - 10/12 | 10 - 12 mm | 20 - 25 mm | 86777830 |
| V Flat - 15 | 15 mm | 30 mm | 86777831 |
| V Flat - 20 | 20 mm | 40 mm | 86777832 |

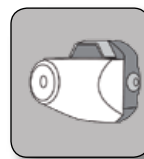

Conical 20
86777817

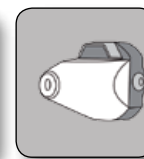

Conical 14
86777818



Special corrugate shoe
76777840



Special shoe support
45° - 80047830
90° - 80047820

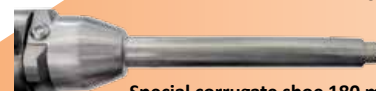

Special corrugate shoe 180 mm
86777800

K-SB 30



K-SB 30 is a compact and ergonomic extruder equipped with a power control device and the safety system "motor block" that doesn't allow the machine to start before it reaches the right temperature. The extruder has an innovative universal feeding system that makes possible to use the machine with different diameters of wire.

- Backlight display
- Two high-brightness LEDs for welding area
- Power regulator - welding speed adjustment
- Security system "motor block / cold start"
- Independent blower
- Thermoregulator double electronic T° control: for blower and extrusion
- Orientable handle
- 360° orientable and replaceable welding shoes

Standard equipment:

K-SB 30 360° rotating teflon shoes, transport case and extruder support;

- Teflon shoe 86777823 90° - a 10,5 mm 360° rotating shoe
- Teflon shoe 86777831 V Flat - 15 mm 360° rotating shoe

ON REQUEST

Teflon shoes, Fixed Lateral Pre-Heating, KIT Geotextile handle

| | |
|----------------------|--|
| Materials | HDPE, PP, PVDF |
| Rod | Ø 3 - 4 - 5 mm; 1/8" - 5/32" - 3/16" |
| Sheets | 1,5 ÷ 30 mm; 1/16" ÷ 1.1" |
| *Output up to | 3 Kg/h HDPE rod Ø 5; 3/16" |
| Dimension | 500 x 310 x 100 mm 19.6" x 12.2" x 3.9" |
| Power supply | 230 Vac 50/60 Hz |
| Total absorbed power | 3350 W |
| Weight | 7,1 Kg (15.6 lb) |

* The maximum extruded capacity varies depending on the material



Special corrugate shoe
76777840



Special corrugate shoe 180 mm
86777800



Special shoe support
45° - 80047830
90° - 80047820

WELDING SHOES K-SB 30



360° Rotating Shoes

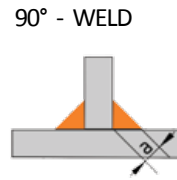

90° - WELD



Shoes Fixed Lateral
Pre-Heating

ACCORDING TO DVS STANDARD

| 360° Rotating Shoes to use with 81567801 | sheets thickness | Article |
|--|------------------|----------|
| 90° - a 5.6 mm | 8 mm | 86777820 |
| 90° - a 7 mm | 10 mm | 86777821 |
| 90° - a 8,4 mm | 12 mm | 86777822 |
| 90° - a 10,5 mm | 15 mm | 86777823 |
| 90° - a 14 mm | 20 mm | 86777824 |
| 90° - a 17,5 mm | 25 mm | 86777825 |
| 90° - a 21 mm | 30 mm | 86777826 |

| Shoes Fixed Lateral Pre-Heating to use with 81567800 | sheets thickness | Article |
|--|------------------|----------|
| 90° - a 5.6 mm | 8 mm | 86777838 |
| 90° - a 7 mm | 10 mm | 86777839 |
| 90° - a 8,4 mm | 12 mm | 86777840 |
| 90° - a 10,5 mm | 15 mm | 86777841 |
| 90° - a 14 mm | 20 mm | 86777842 |
| 90° - a 17,5 mm | 25 mm | 86777843 |
| 90° - a 21 mm | 30 mm | 86777844 |

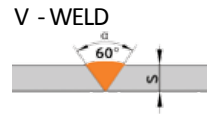

V - WELD

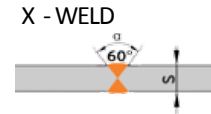

X - WELD

ACCORDING TO DVS STANDARD

| 360° Rotating Shoes to use with 81567801 | V weld "S" | X weld "S" | Article |
|--|------------|------------|----------|
| V Flat - 8 | 8 mm | 16 mm | 86777829 |
| V Flat - 10/12 | 10 - 12 mm | 20 - 25 mm | 86777830 |
| V Flat - 15 | 15 mm | 30 mm | 86777831 |
| V Flat - 20 | 20 mm | 40 mm | 86777832 |

| Shoes Fixed Lateral Pre-Heating to use with 81567800 | V weld "S" | X weld "S" | Article |
|--|------------|------------|----------|
| V Flat - 8 | 8 mm | 16 mm | 86777847 |
| V Flat - 10/12 | 10 - 12 mm | 20 - 25 mm | 86777848 |
| V Flat - 15 | 15 mm | 30 mm | 86777849 |
| V Flat - 20 | 20 mm | 35 - 40 mm | 86777850 |
| V Flat - 25 | 25 mm | - | 86777851 |
| V Flat - 30 | 30 mm | - | 86777852 |

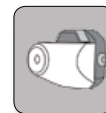

Conical 20
86777817

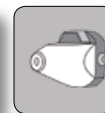

Conical 14
86777818



Geotextile
86777814

LATERAL PRE-HEATING NOZZLE



Lateral
Pre-Heating
adapter 81567800



Nozzle
18 mm
78947844C



Nozzle
25 mm
78947854C



Nozzle
32 mm
78947864C

K-SB 40



K-SB 40 is a compact and ergonomic extruder equipped with a power control device and the safety system "motor block" that doesn't allow the machine to start before it reaches the right temperature. The extruder has an innovative universal feeding system that makes possible to use the machine with different diameters of wire.

- Backlight display
- Two high-brightness LEDs for welding area
- Power regulator - welding speed adjustment
- Security system "motor block / cold start"
- Independent blower
- Thermoregulator double electronic T ° control: for blower and extrusion
- Orientable handle
- 360° orientable and replaceable welding shoes

Standard equipment:

K-SB 40 360° rotating teflon shoes, transport case and extruder support;

- Teflon shoe 86777823 90° - a 10,5 mm 360° rotating shoe
- Teflon shoe 86777831 V Flat - 15 mm 360° rotating shoe

ON REQUEST

Teflon shoes, Fixed Lateral Pre-Heating, KIT Geotextile handle

| | |
|----------------------|---|
| Materials | HDPE, PP |
| Rod | ∅ 4 - 5 mm; 5/32" - 3/16" |
| Sheets | 1,5 ÷ 30 mm; 1/16" ÷ 1.1" |
| *Output: up to | 4 Kg/h HDPE rod ∅ 5; 3/16" |
| Dimension | 640 x 200 x 100 mm 25.2" x 7.9" x 3.9" |
| Power supply | 230 Vac 50/60 Hz |
| Total absorbed power | 3500 W |
| Weight | 7,6 Kg (16.7 lb) |

* The maximum extruded capacity varies depending on the material



Special corrugate shoe
76777840



Special shoe support
45° - 80047830
90° - 80047820



Special corrugate shoe 180 mm
86777800

WELDING SHOES K-SB 40



360° Rotating Shoes

90° - WELD

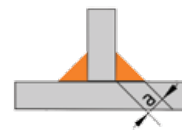

Shoes Fixed Lateral Pre-Heating

ACCORDING TO DVS STANDARD

| 360° Rotating Shoes to use with 81567801 | sheets thickness | Article |
|--|------------------|----------|
| 90° - a 5.6 mm | 8 mm | 86777820 |
| 90° - a 7 mm | 10 mm | 86777821 |
| 90° - a 8,4 mm | 12 mm | 86777822 |
| 90° - a 10,5 mm | 15 mm | 86777823 |
| 90° - a 14 mm | 20 mm | 86777824 |
| 90° - a 17,5 mm | 25 mm | 86777825 |
| 90° - a 21 mm | 30 mm | 86777826 |

| Shoes Fixed Lateral Pre-Heating to use with 81567800 | sheets thickness | Article |
|--|------------------|----------|
| 90° - a 5.6 mm | 8 mm | 86777838 |
| 90° - a 7 mm | 10 mm | 86777839 |
| 90° - a 8,4 mm | 12 mm | 86777840 |
| 90° - a 10,5 mm | 15 mm | 86777841 |
| 90° - a 14 mm | 20 mm | 86777842 |
| 90° - a 17,5 mm | 25 mm | 86777843 |
| 90° - a 21 mm | 30 mm | 86777844 |
| 90° - a 24,5 mm | 35 mm | 86777845 |

V - WELD

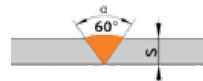

X - WELD

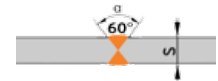

ACCORDING TO DVS STANDARD

| 360° Rotating Shoes to use with 81567801 | V weld "S" | X weld "S" | Article |
|--|------------|------------|----------|
| V Flat - 8 | 8 mm | 16 mm | 86777829 |
| V Flat - 10/12 | 10 - 12 mm | 20 - 25 mm | 86777830 |
| V Flat - 15 | 15 mm | 30 mm | 86777831 |
| V Flat - 20 | 20 mm | 40 mm | 86777832 |

| Shoes Fixed Lateral Pre-Heating to use with 81567800 | V weld "S" | X weld "S" | Article |
|--|------------|------------|----------|
| V Flat - 8 | 8 mm | 16 mm | 86777847 |
| V Flat - 10/12 | 10 - 12 mm | 20 - 25 mm | 86777848 |
| V Flat - 15 | 15 mm | 30 mm | 86777849 |
| V Flat - 20 | 20 mm | 35 - 40 mm | 86777850 |
| V Flat - 25 | 25 mm | - | 86777851 |
| V Flat - 30 | 30 mm | - | 86777852 |
| V Flat - 35 | 35 mm | - | 86777853 |



Conical 20
86777817



Conical 14
86777818



Geotextile
86777814

LATERAL PRE-HEATING NOZZLE



Lateral Pre-Heating adapter 81567800

+

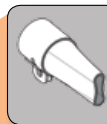

Nozzle 18 mm
78947844C

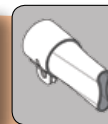

Nozzle 25 mm
78947854C



Nozzle 32 mm
78947864C



Nozzle 48 mm
78947874C



K-SB 50



K-SB 50 Back handle

K-SB 50 is a powerful extruder indispensable for jobs that require a high output of extruded material. K-SB 50 is suitable for joining linings and geo-textiles, sheets, thick pipes and for all those welds that are required to resist to continuous stress. It is capable of up to 5 Kg/h of extruded material.

- Backlight display
- Welding - area spot light LEDs
- Temperature control safety system cold start control
- Built - in blower
- Double T° controller for blower and extrusion chamber
- Rotating side - handle

Standard equipment:

- K-SB 50 Back Handle - Fixed Lateral Pre-Heating with nozzle 32 mm (78947864C)
- K-SB 50 Pistol Grip - Fixed Lateral Pre-Heating with nozzle 32 mm (78947864C)
- Transport case and extruder support
- Teflon shoe 86777843 90° - a 17,5 mm Fixed Lateral Pre-Heating
- Teflon shoe 86777851 V Flat - 25 mm Fixed Lateral Pre-Heating

ON REQUEST

Teflon shoes, Kit 360° rotating teflon shoes, KIT Geotextile handle

| Materials | HDPE, PP |
|----------------------|--|
| Rod | Ø 4 - 5 mm; 5/32" - 3/16" |
| Sheets | 1,5 ÷ 40 mm; 1/16" ÷ 1.5" |
| *Output up to | 5 Kg/h HDPE rod Ø 5; 3/16" |
| Dimension: | (a) 720 x 260 x 100 mm 28.3" x 10.2" x 3.9" |
| (a) Back Handle | |
| (B) Pistol Grip | (b) 600 x 330 x 100 mm 23.6" x 13" x 3.9" |
| Power supply | 230 Vac 50/60 Hz |
| Total absorbed power | 4000 W |
| Weight | 9 Kg (19.8 lb) |

* The maximum extruded capacity varies depending on the material



K-SB 50 Pistol Grip

K-SB 60



K-SB 60 is a powerful and light extruder indispensable for jobs that require a high output of extruded material. It is capable of up to 6.2 Kg/h of extruded material. K-SB 60 is suitable for joining linings and geo-textiles, sheets, thick pipes and for all those welds that are required to resist to continuous stress.

- Backlight display
- Welding - area spot light LEDs
- Temperature control safety system cold start control
- Built - in blower
- Double T° controller for blower and extrusion chamber
- Rotating side - handle

Standard equipment:

- K-SB 60 Fixed Lateral Pre-Heating with nozzle 32 mm (78947864C)
- Transport case and extruder support
- Teflon shoe 86777844 90° - a 21 mm Fixed Lateral Pre-Heating
- Teflon shoe 86777852 V Flat - 30 mm Fixed Lateral Pre-Heating

ON REQUEST

Teflon shoes, Kit 360° rotating teflon shoes, KIT Geotextile handle

| Materials | HDPE, PP |
|----------------------|--|
| Rod | Ø 4 - 5 mm; 5/32" - 3/16" |
| Sheets | 1,5 ÷ 40 mm; 1/16" ÷ 1.5" |
| *Output up to | 6.2 Kg/h HDPE rod Ø 5; 3/16" |
| Dimension | 730 x 260 x 100 mm 28.7" x 10.2" x 3.9" |
| Power supply | 230 Vac 50/60 Hz |
| Total absorbed power | 4200 W |
| Weight | 9,3 Kg (20.5 lb) |

* The maximum extruded capacity varies depending on the material



Special corrugate shoe
7677840

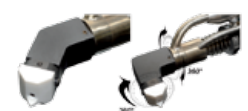

Special shoe support
45° - 80047830
90° - 80047820

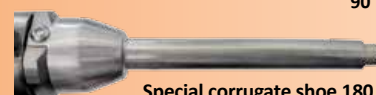

Special corrugate shoe 180 mm
8677800



WELDING SHOES K-SB 50 / K-SB 60



Kit 360° Pre-Heating
adapter 81567801
to use with
360° Rotating Shoes



360° Rotating Shoes

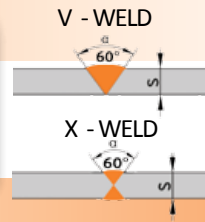

Shoes Fixed Lateral
Pre-Heating



Shoes Fixed Lateral
Pre-Heating

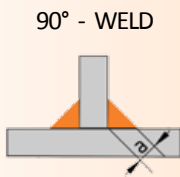

360° Rotating Shoes

ACCORDING TO DVS STANDARD

| 360° Rotating Shoes to use with 81567801 | V weld "S" | X weld "S" | Article |
|--|------------|------------|----------|
| V Flat - 8 | 8 mm | 16 mm | 86777829 |
| V Flat - 10/12 | 10 - 12 mm | 20 - 25 mm | 86777830 |
| V Flat - 15 | 15 mm | 30 mm | 86777831 |
| V Flat - 20 | 20 mm | 40 mm | 86777832 |

| Shoes Fixed Lateral Pre-Heating to use with 81567800 | V weld "S" | X weld "S" | Article |
|--|------------|------------|----------|
| V Flat - 8 | 8 mm | 16 mm | 86777847 |
| V Flat - 10/12 | 10 - 12 mm | 20 - 25 mm | 86777848 |
| V Flat - 15 | 15 mm | 30 mm | 86777849 |
| V Flat - 20 | 20 mm | 35 - 40 mm | 86777850 |
| V Flat - 25 | 25 mm | - | 86777851 |
| V Flat - 30 | 30 mm | - | 86777852 |
| V Flat - 35 | 35 mm | - | 86777853 |
| V Flat - 40 | 40 mm | - | 86777854 |

ACCORDING TO DVS STANDARD

| Shoes Fixed Lateral Pre-Heating to use with 81567800 | sheets thickness | Article |
|--|------------------|----------|
| 90° - a 7 mm | 10 mm | 86777839 |
| 90° - a 8,4 mm | 12 mm | 86777840 |
| 90° - a 10,5 mm | 15 mm | 86777841 |
| 90° - a 14 mm | 20 mm | 86777842 |
| 90° - a 17,5 mm | 25 mm | 86777843 |
| 90° - a 21 mm | 30 mm | 86777844 |
| 90° - a 24,5 mm | 35 mm | 86777845 |
| 90° - a 28 mm | 40 mm | 86777846 |

| 360° Rotating Shoes to use with 81567801 | sheets thickness | Article |
|--|------------------|----------|
| 90° - a 7 mm | 10 mm | 86777821 |
| 90° - a 8,4 mm | 12 mm | 86777822 |
| 90° - a 10,5 mm | 15 mm | 86777823 |
| 90° - a 14 mm | 20 mm | 86777824 |
| 90° - a 17,5 mm | 25 mm | 86777825 |
| 90° - a 21 mm | 30 mm | 86777826 |
| 90° - a 24,5 mm | 35 mm | 86777827 |
| 90° - a 28 mm | 40 mm | 86777828 |

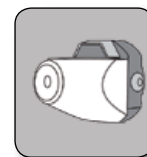

Conical 20
86777817

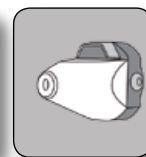

Conical 14
86777818



Geotextile
86777814

LATERAL PRE-HEATING NOZZLE



Nozzle 18 mm
78947844C



Nozzle 25 mm
78947854C

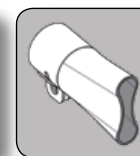

Nozzle 32 mm
78947864C

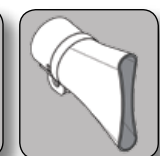

Nozzle 48 mm
78947874C



PRODUCTS OVERVIEW

| | K - SB 20 | K - SB 30 | K - SB 40 | K - SB 50 | K - SB 60 |
|------------------------------------|---|--|---|--|--|
| MATERIALS | HDPE, PP, PVDF | HDPE, PP, PVDF | HDPE, PP | HDPE, PP | HDPE, PP |
| * OUTPUT | 2 Kg/h HDPE rod Ø 4 mm; 5/32" | 3 Kg/h HDPE rod Ø 5; 3/16" | 4 Kg/h HDPE rod Ø 5; 3/16" | 5 Kg/h HDPE rod Ø 5; 3/16" | 6,2 Kg/h HDPE rod Ø 5; 3/16" |
| ROD | 3 - 4 mm 1/8" - 5/32" | 3 - 4 - 5 mm; 1/8" - 5/32" - 3/16" | 4 - 5 mm; 5/32" - 3/16" | 4 - 5 mm; 5/32" - 3/16" | 4 - 5 mm; 5/32" - 3/16" |
| WEIGHT | 6.9 Kg (15.2 lb) | 7,1 Kg (15.6 lb) | 7,6 Kg (16.7 lb) | 9 Kg (19.8 lb) | 9,3 Kg (20.5 lb) |
| DIMENSIONS | 450 x 310 x 100 mm; 17.7" x 12.2" x 3.9" | 500 x 310 x 100 mm 19.6" x 12.2" x 3.9" | 640 x 200 x 100 mm 25.2" x 7.9" x 3.9" | Back handle 720 x 260 x 100 mm 28.3" x 10.2" x 3.9" Pistol grip 600 x 330 x 100 mm 23.6" x 13" x 3.9" | 730 x 260 x 100 mm 28.7" x 10.2" x 3.9" |
| MAX ABSORBED POWER | 3100 W 230 V 50/60 Hz | 3350 W 230 V 50/60 Hz | 3500 W 230 V 50/60 Hz | 4000 W 230 V 50/60 Hz | 4200 W 230 V 50/60 Hz |
| GEO-TEXTILE | | | • | • | • |
| CONTAINER CONSTRUCTION | • | • | • | • | • |
| BUILDING OF TANKS AND FILTERS | • | • | • | • | • |
| BUILDING OF FUMES TREATMENT TOWERS | • | • | • | • | • |

* The maximum extruded capacity varies depending on the material



RELATED SERVICES

RITMO offers turnkey solutions to its customers: welding rods and rod dispensers are available

Welding rods:
HDPE Ø 4 - 5 mm; 5/32" - 3/16"
PP Ø 3 - 4 mm; 1/8" - 5/32"



FLOW LINE

FLOW Line is used for a limitless applications and sectors: plastic works, construction, material recycling, bumpers fixing, signage and so on.

Through a precise hot airflow (maximum temperature at 700° C) is possible to weld a plastic rod, performing repairs, bending materials, shaping, creating joints, overlapping sheaths and sheets, drying non-flammable paints and varnishes, defrosting etc.

The HD-PRO and SPHERA models integrate powerful fan to guarantee a precise hot airflow that is necessary to use the tool at its best.

The STYLO model is equipped with a temperature power regulator but it is very light and versatile as well, in fact it uses an external compressed air supply. These characteristics make STYLO compact and handy. STYLO is supplied with round nozzle 5 mm cod 67204000

A large number of tips and accessories are available! Providing new solutions to always welding at best.

All models are available in 120V or 230V.



HD-PRO



SPHERA



STYLO

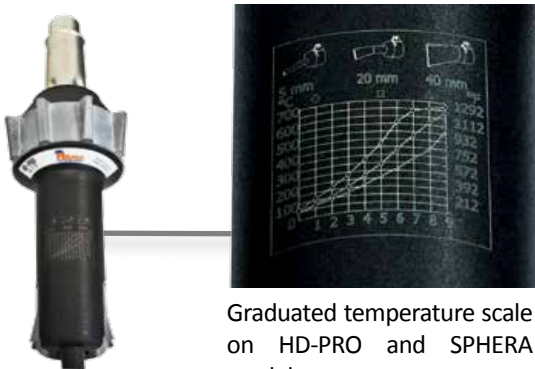

Graduated temperature scale on HD-PRO and SPHERA models.

| | HD-PRO | SPHERA | STYLO |
|--------------------------|------------------------------|------------------------------|--------------------------|
| Power supply | 1650 W 120 V 50/60 Hz | 1650 W 120 V 50/60 Hz | 1300 W 120 V 50/60 Hz |
| | 1500 W 230 V 50/60 Hz | 1500 W 230 V 50/60 Hz | 1500 W 230 V 50/60 Hz |
| Output Temperature | MAX 700° C | MAX 700° C | 20 ÷ 700° C |
| Air demand/ Air quantity | - | - | 80 ÷ 250 l/min |
| Noise level | < 70 dB | < 70 dB | - |
| Weight | 1,4 Kg with connection cable | 1,2 Kg with connection cable | 0,4 Kg |
| Protection class | II (double insulated) | II (double insulated) | II (double insulated) |



Round nozzle 5 mm
cod 67204000
Standard composition
with STYLO model

**NOZZLES
FOR ALL MODELS**



Speed welding
round nozzle 3 mm
cod 67205010



Speed welding
round nozzle 4 mm
cod 67205011



Speed welding
round nozzle 5 mm
cod 67205012



Tacking tip
cod 67205015



Speed welding
triangular 5 mm
cod 67205013



Speed welding
triangular 5,7 mm
cod 67205000



Speed welding
triangular 7 mm
cod 67205001



Speed welding
triangular 7,5 mm
cod 67205014



Adapter with
female thread M10
cod 67204007

**NOZZLES
FOR ALL MODELS**



Tacking tip with
thread M 10
cod 67205004



Triangular nozzle
5 mm with
thread M 10
cod 67205008



Triangular nozzle
5,7 mm with
thread M 10
cod 67205002



Triangular nozzle
7 mm with
thread M 10
cod 67205003



Triangular nozzle
7,5 mm with
thread M 10
cod 67205009



Tacking tip
hooked with
thread M 10
cod 67205017



Round nozzle
3 mm with
thread M 10
cod 67205005



Round nozzle
4 mm with
thread M 10
cod 67205006



Round nozzle
5 mm with
thread M 10
cod 67205007

ACCESSORIES AND SPARE PARTS



Flat nozzle
20 mm
cod 67204002



Flat nozzle
20 mm 15°
cod 67204215



Flat nozzle
40 mm
cod 67204003



Flat perforated
nozzle 40 mm
cod 67204004



Shrink round
nozzle 15 mm
cod 67204005



Shrink reflector
cod 67205016



Weld seam slide
cod 67205021



Pressure roller
1-armed 28 mm
bearing mounted
cod 67206994



Pressure roller
2-armed 45 mm
cod 67207000
bearing mounted
cod 67206998



Pressure roller
1-armed 45 mm
cod 67207001
bearing mounted
cod 67206997



Pressure roller
80 mm
cod 67207002
bearing mounted
cod 67206996



Pressure roller
5 mm for round
wire
cod 67207005



Pressure roller
1-armed 45 mm
and 45°
cod 67207006
bearing mounted
cod 67206995



Grooving tool
cod 67207011



Quarter moon
knife
cod 67207010



Seam tester
cod 67207014



Insulating tube
cod 57214011



Heating element
230 V - 1500 W
cod 57102007

PLASTIC FABRICATION SHEET WELDING

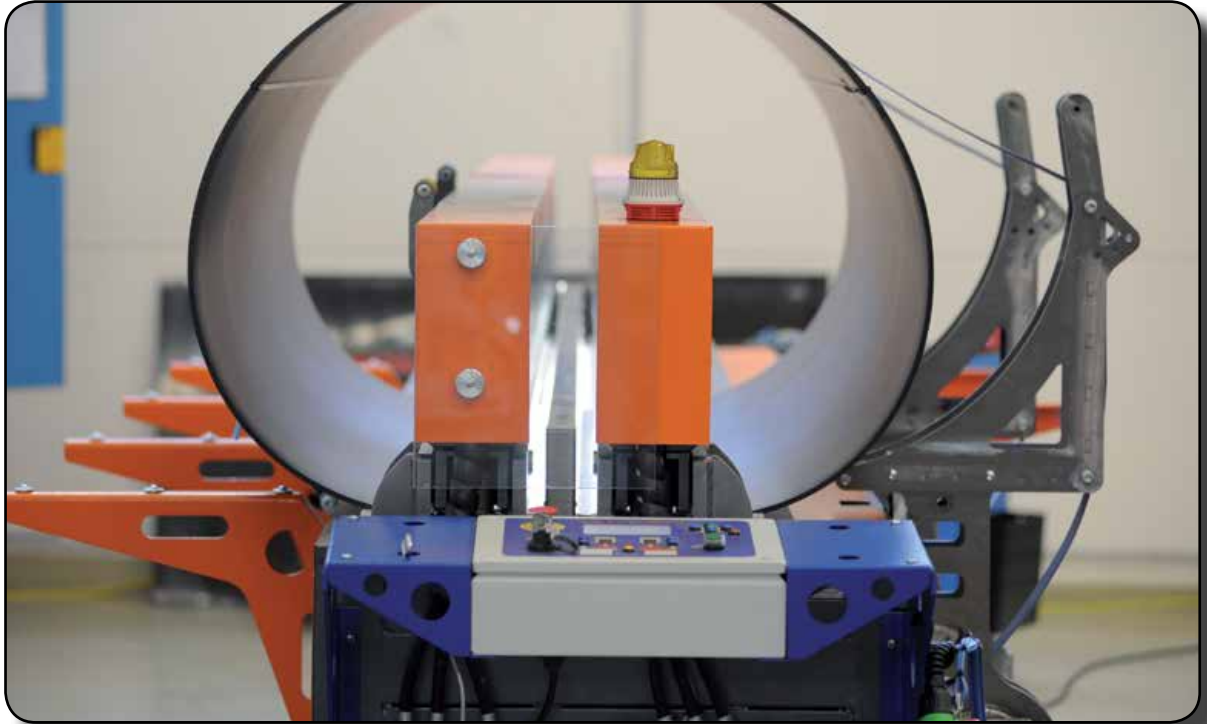

MAIN APPLICATIONS

- Mining technology
- Building industry
- Mechanical engineering
- Livestock breeding
- Aquaculture and swimming pools
- Chemical engineering and tank building
- Surface treatment metals
- Buffer tanks
- Beverage and food industry
- Pump manufacturing
- Ventilation system and ventilator manufacture
- Environment and waste water tanks
- Nautical sector



POLYFUSION 1-25

POLYFUSION 1-25 is compact and easy to use manual welders for HDPE and PP sheets from one meters wide and 2 mm to 25 mm thickness (1/8" ÷ 1"). The welding cycle is handled by a control panel which commands the hydraulic gearcase. The control panel can be adjusted horizontally to assist the operator. The machine can operate in compliance with the DVS 2207-1 and DVS 2207-11.

The sheets are fixed to the machine body by manual handwheels; the locking arm has an articulated joint that allows its opening and the easy extraction of the welded sheets. The working surface of the machine body has a graduated scale on both sides, which speeds the positioning and centering of the pieces to be welded.

The manual heating plate, located under the machine body, has a height adjustment handwheel. The temperature is controlled by a built-in high-precision electronic thermoregulator, "Digital Dragon".

The welding machine has a small modulated sustaining frame to perform 90 ° weldings.

The machine can also weld twin-wall HDPE sheets.

There's a practical shelf at the base of the steel frame, which can be used to place some tools.

POLYFUSION 1-25 is available in 230 V (110 V on request).

TECHNICAL FEATURES



| Model | Polyfusion 1-25 |
|-----------------------------|--|
| Working range | 2 ÷ 25 mm; 1/8" ÷ 1" |
| Materials | HDPE, PP |
| Power supply | 110 V Single Phase 50/60 Hz 230 V Single Phase 50/60 Hz |
| Total absorbed power | 1580 W (230 V) |
| Types of welding | line, 90°, circular |
| Max. working width | 1000 mm; 3.28 ft |
| Min. weldable thickness | 2 mm ; 1/8" |
| Max. weldable thickness | 25,4 mm; 1" |
| Pressure range | 0 ÷ 150 bar |
| Weight standard composition | 118 Kg (260 lb) |
| Dimensions machine body | 1420 x 900 x 1190 mm 56" x 35.4" x 46.8" |



POLYFUSION 2-25

POLYFUSION 2-50

- **COMPACT AND EASY TO USE**
- **MAX WORKING WIDTH: 2 M**
- **MIN THICKNESS 3 mm**
- **SHEETS: HDPE, PP, TWIN WALL SHEETS**
- **MANUAL WELDERS**
- **TYPE OF WELDING: STRAIGHT BUTT FUSION, 90°.**



POLYFUSION 2-25 and POLYFUSION 2-50 are compact and easy to use manual welders for HDPE and PP sheets from two meters wide and 3÷25 mm or 1/8"÷1" thickness (mod. POLYFUSION 2-25); and 3÷50 mm or 1/8"÷2" thickness (mod. POLYFUSION 2-50). The machines can also weld twin-wall sheets. The machine can operate in compliance with the DVS 2207-1 and DVS 2207-11.

The welding cycle is handled by a control panel which commands the hydraulic gearcase.

The control panel can be adjusted horizontally to assist the operator during the set-up and welding phases, to work always in the clearance.

The sheets are fixed to the machine body by manual handwheel bars; the locking arm has an articulated pivot joint that allows its opening and the easy extraction of the welded sheets.

The working surface of the machine body has a graduated scale on both sides, which speeds the positioning and centering of the pieces to be welded.

The manual lever lifting heating plate, located under the machine body, has a height adjustment handwheel to allow the 90° welding.

The heater temperature is controlled by a built-in high-precision electronic thermoregulator.



Manual Control Panel

TECHNICAL FEATURES

| | | |
|-----------------------------|---|---|
| Model | POLYFUSION 2-25 | POLYFUSION 2-50 |
| Working range | 3 ÷ 25 mm; 1/8" ÷ 1" | 3 ÷ 50 mm; 1/8" ÷ 2" |
| Materials | HDPE, PP, Twin Wall sheets | HDPE, PP, Twin Wall sheets |
| Power supply | 400 V T. Phase 50/60 Hz | 400 V T. Phase 50/60 Hz |
| Total absorbed power | 5900 W | 8300 W |
| Types of welding | Line, 90° (on request) | Line, 90° (on request) |
| Max. working width | 2000 mm; 6.56 ft | 2000 mm; 6.56 ft |
| Min. weldable thickness | 3 mm; 1/8" | 3 mm; 1/8" |
| Max. weldable thickness | 25 mm; 1" For details contact RITMO S.P.A. | 50 mm; 2" For details contact RITMO S.P.A. |
| Pressure range | 0 ÷ 170 bar | 0 ÷ 170 bar |
| Weight standard composition | 1100 Kg (2425 lb) | 1150 Kg (2535 lb) |
| Dimensions (W x D x H) | 3200 x 2000 x 1200 mm 126" x 78.7" x 47.2" | 3200 x 2000 x 1200 mm 126" x 78.7" x 47.2" |



POLYFUSION 2-100

- **HYDRAULIC ARM**
- **MAX WORKING WIDTH: 2 M**
- **THICKNESS 3 ÷ 100 mm (1/8" ÷ 4")**
- **SHEETS: HDPE, PP, TWIN WALL SHEETS**
- **MANUAL WELDERS**
- **TYPE OF WELDING: STRAIGHT BUTT FUSION, 90°.**



Manual control panel

POLYFUSION 2-100 is compact and easy to use manual welders for HDPE and PP sheets from two meters wide and 3 mm to 100 mm thickness. The welding cycle is handled by a control panel which commands the hydraulic gearcase. The control panel can be adjusted horizontally to assist the operator. The machine can operate in compliance with the DVS 2207-1 and DVS 2207-11.

The sheets are fixed to the machine body by hydraulic arm. The locking arm has an articulated joint that allows its opening and the easy extraction of the welded sheets. The working surface of the machine body has a graduated scale on both sides, which speeds the positioning and centering of the pieces to be welded.

The manual heating plate, located under the machine body, has a height adjustment handwheel. The temperature is controlled by a built-in high-precision electronic thermoregulator.

The machine can also weld twin-wall sheets.

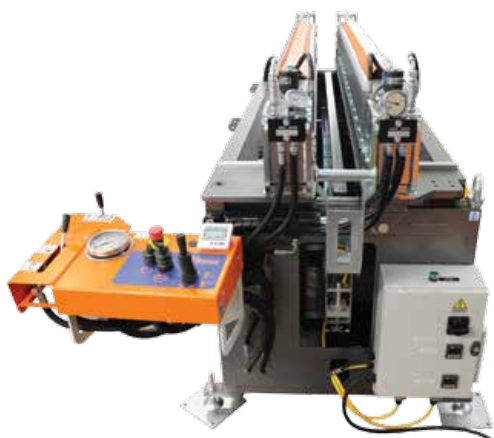
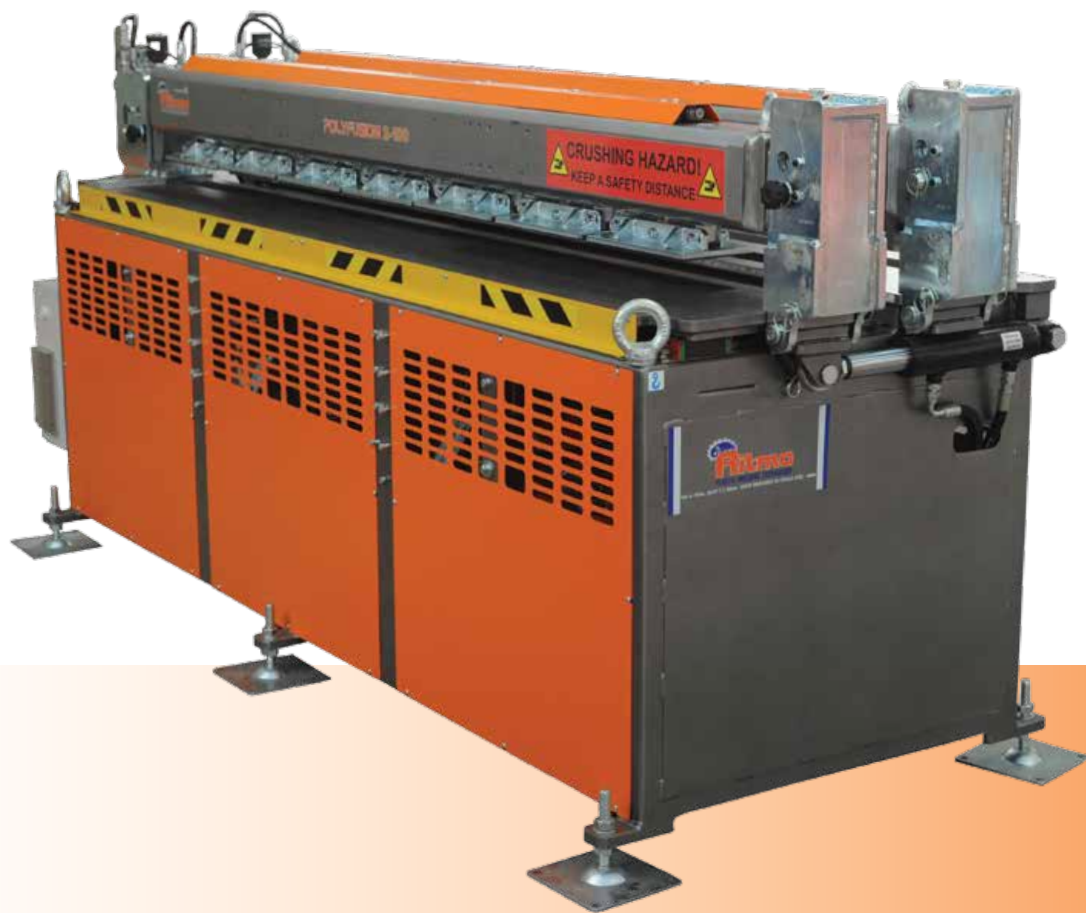

TECHNICAL FEATURES

| | |
|-----------------------------|---|
| Materials | HDPE, PP, Twin Wall sheets |
| Working range | 3 ÷ 100 mm; 1/8" ÷ 4" |
| Power supply | 400 V Three Phase 50/60 Hz |
| Total absorbed power | 10300 W |
| Types of welding | Line, 90° (on request) |
| Max. working width | 2000 mm - 6.56 ft |
| Min. weldable thickness | 3 mm; 1/8" |
| Max. weldable thickness | 100 mm; 4" |
| Pressure range | 0 ÷ 170 bar |
| Weight standard composition | 1200 Kg (2645 lb) |
| Dimensions machine body | 3440 x 2000 x 1450 mm 135.4" x 78.7" x 57" |



POLYFUSION 3-30

POLYFUSION 3-30 is CNC automatic butt fusion machines, suitable for welding thermoplastic sheets made of HDPE, PP, PVC*. The butt fusion machine is also able to weld twin-wall HDPE and PP sheets. The machine can operate in compliance with the DVS 2207-1 and DVS 2207-11.

POLYFUSION 3-30 is an hydraulic welding machine equipped with a control panel, which allows easily and safely setting and performance of the whole welding process. According to the user's needs, it is also possible to input the type of material and the dimension of the thermoplastic sheet, and therefore proceed to weld. The welding area and the clamping bars are compacts; this allow to build a small circular joint.

The CNC can store up to 4000 cycles. It is possible to download the PDF file via USB slot; possibility to pre-set 15 customized welding cycles. The machine has foldable side supports.

POLYFUSION 3-30 performs different types of weld horizontal, circular and 90° joints.

Types of welding



TECHNICAL FEATURES

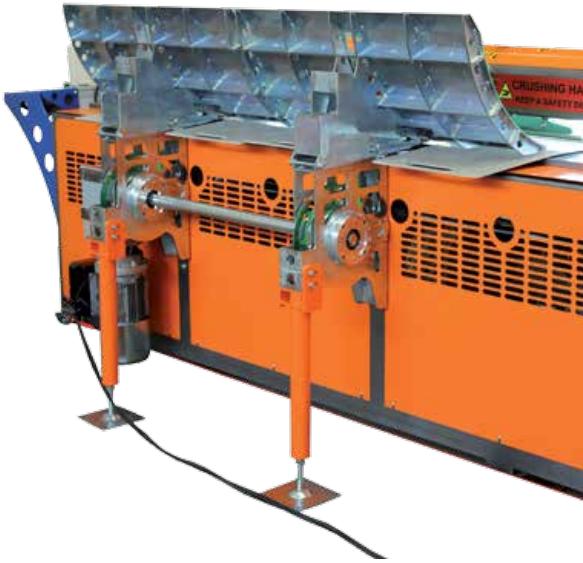

| | |
|----------------------------|---|
| Materials | PP, PVC*, HDPE, Twin Wall sheets |
| Power supply | 400 V Three Phase 50/60 Hz |
| Total absorbed power | 12500 W |
| Types of welding | Line, 90° (on request) Circular (on request) *min Ø 500 mm For details contact RITMO S.P.A. |
| Max. working width ** | 3000 mm - 9.84 ft |
| Min. weldable thickness | 3 mm - 1/8" |
| Max. weldable thickness ** | 30 mm - 1.2" |
| Compress air supply | 10 bar |
| Memory | 4000 cycles |
| Report | PDF |
| Pre-set customized | 15 |
| Dimensions machine body | 4200 x 1540 x 840 mm 165.3" x 60.6" x 33" (folded brackets) 4200 x 1540 x 1960 mm 165.3" x 60.6" x 77.2" (unfolded brackets) |

* Contact RITMO

** The welding dimensions refer to PP / HDPE with welding pressure of 0.17 N / mm²





POLYFUSION 3-50

POLYFUSION 3-50 is CNC automatic butt fusion machines, suitable for welding thermoplastic sheets made of HDPE, PP, PVC*. The butt fusion machine is also able to weld twin-wall HDPE and PP sheets. The machine can operate in compliance with the DVS 2207-1 and DVS 2207-11.

POLYFUSION is an hydraulic welding machine equipped with a control panel, which allows easily and safely setting and performance of the whole welding process.

According to the user's needs, it is also possible to input the type of material and the dimension of the thermoplastic sheet, and therefore proceed to weld. The CNC can store up to 4000 cycles. It is possible to download the PDF file via USB slot; possibility to pre-set 15 customized welding cycles. The machine has foldable side supports.

The machine can be operated both horizontally and vertically, which allow to perform different types of weld (horizontal, circular and vertical joints).



TECHNICAL FEATURES

Types of welding



| | |
|----------------------------|---|
| Materials | PP, PVC*, HDPE, Twin Wall sheets |
| Power supply | 400 V Three Phase 50/60 Hz |
| Total absorbed power | 12500 W |
| Types of welding | Line, 90° (on request) Circular (on request) *min Ø 700 mm For details contact RITMO S.P.A. |
| Max. working width ** | 3000 mm - 9.84 ft |
| Min. weldable thickness | 3 mm - 1/8" |
| Max. weldable thickness ** | 50 mm - 2" |
| Compress air supply | 10 bar |
| Memory | 4000 |
| REPORT | PDF |
| Pre-set customized | 15 |
| Dimensions machine body | 4200 x 1540 x 840 mm 165.3" x 60.6" x 33" (folded brackets) 4200 x 1540 x 1960 mm 165.3" x 60.6" x 77.2" (unfolded brackets) |

* Contact RITMO

** The welding dimensions refer to PP / HDPE with
welding pressure of 0.17 N / mm²





POLYFUSION 4-30

POLYFUSION 4-30 is CNC automatic butt fusion machines, suitable for welding thermoplastic sheets made of HDPE, PP, PVC*. The butt fusion machine is also able to weld twin-wall HDPE and PP sheets. The machine can operate in compliance with the DVS 2207-1 and DVS 2207-11.

POLYFUSION 4-30 is an hydraulic welding machine equipped with a control panel, which allows easily and safely setting and performance of the whole welding process. According to the user's needs, it is also possible to input the type of material and the dimension of the thermoplastic sheet, and therefore proceed to weld. The welding area and the clamping bars are compact; this allow to build a small circular joint.

The CNC can store up to 4000 cycles. It is possible to download the PDF file via USB slot; possibility to pre-set 15 customized welding cycles. The machine has foldable side supports.

POLYFUSION 4-30 performs different types of weld horizontal, circular and 90° joints.

Types of welding



TECHNICAL FEATURES

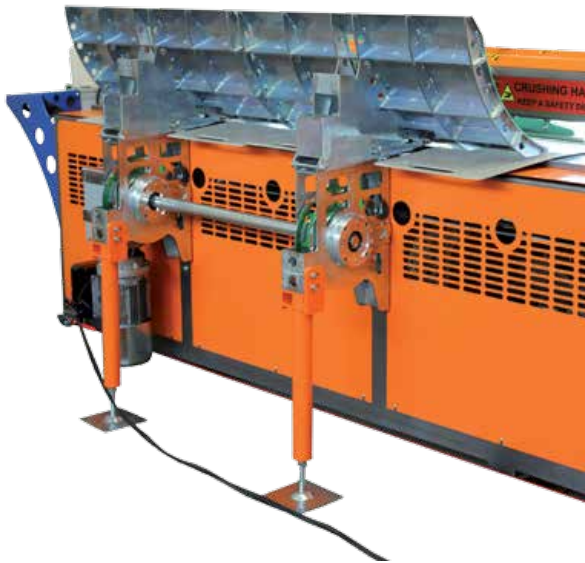

* Contact RITMO

** The welding dimensions refer to PP / HDPE with welding pressure of 0.17 N / mm²

| | |
|----------------------------|---|
| Materials | PP, PVC*, HDPE, Twin Wall sheets |
| Power supply | 400 V Three Phase 50/60 Hz |
| Total absorbed power | 14500 W |
| Types of welding | Line, 90° (on request) Circular (on request) *min Ø 500 mm For details contact RITMO S.P.A. |
| Max. working width ** | 4000 mm - 13.12 ft |
| Min. weldable thickness | 3 mm - 1/8" |
| Max. weldable thickness ** | 30 mm - 1.2" |
| Compress air supply | 10 bar |
| Memory | 4000 cycles |
| Report | PDF |
| Pre-set customized | 15 |
| Dimensions machine body | 5200 x 1260 x 840 mm 204,7" x 49.6" x 33" (folded brackets) 5200 x 1260 x 1960 mm 204,7" x 49.6" x 77.2" (unfolded brackets) |





POLYFUSION 4-50

POLYFUSION 4-50 is CNC automatic butt fusion machines, suitable for welding thermoplastic sheets made of HDPE, PP, PVC*. The butt fusion machine is also able to weld twin-wall HDPE and PP sheets. The machine can operate in compliance with the DVS 2207-1 and DVS 2207-11.

POLYFUSION is an hydraulic welding machine equipped with a control panel, which allows easily and safely setting and performance of the whole welding process.

According to the user's needs, it is also possible to input the type of material and the dimension of the thermoplastic sheet, and therefore proceed to weld. The CNC can store up to 4000 cycles. It is possible to download the PDF file via USB slot; possibility to pre-set 15 customized welding cycles. The machine has foldable side supports.

The machine can be operated both horizontally and vertically, which allow to perform different types of weld (horizontal, circular and vertical joints).

Types of welding



TECHNICAL FEATURES



watch the video

| | |
|----------------------------|---|
| Materials | PP, PVC*, HDPE, Twin Wall sheets |
| Power supply | 400 V Three Phase 50/60 Hz |
| Total absorbed power | 14500 W |
| Types of welding | Line, 90° (on request) Circular (on request) *min Ø 700 mm For details contact RITMO S.P.A. |
| Max. working width ** | 4000 mm - 13.12 ft |
| Min. weldable thickness | 3 mm - 1/8" |
| Max. weldable thickness ** | 50 mm - 2" |
| Compress air supply | 10 bar |
| Memory | 4000 cycles |
| Report | PDF |
| Pre-set customized | 15 |
| Dimensions machine body | 5200 x 1540 x 840 mm (folded brackets) 204,7" x 60.6" x 33" 5200 x 1540 x 1960 mm 204,7" x 60.6" x 77.2" (unfolded brackets) |

* Contact RITMO

** The welding dimensions refer to PP / HDPE with welding pressure of 0.17 N / mm²



PRODUCTS OVERVIEW

| | POLYFUSION 1 - 25 | POLYFUSION 2 - 25 | POLYFUSION 2 - 50 | POLYFUSION 2 - 100 | POLYFUSION 3 - 30 | POLYFUSION 3 - 50 | POLYFUSION 4 - 30 | POLYFUSION 4 - 50 |
|--|----------------------|----------------------|----------------------|-----------------------|----------------------|----------------------|----------------------|----------------------|
| Min. weldable thickness | 2 mm - 1/8" | 3 mm - 1/8" | 3 mm - 1/8" | 3 mm - 1/8" | 3 mm - 1/8" | 3 mm - 1/8" | 3 mm - 1/8" | 3 mm - 1/8" |
| Max. weldable thickness *** | 25 mm - 1" | 25 mm - 1" | 50 mm - 2" | 100 mm - 4" | 30mm-1.18" | 50 mm - 2" | 30 mm - 1.18" | 50 mm - 2" |
| Max working width *** | 1 m - 3.28 ft | 2 m - 6.56 ft | 2 m - 6.56 ft | 2 m - 6.56 ft | 3 m - 9.84 ft | 3 m - 9.84 ft | 4 m - 13.12 ft | 4 m - 13.12 ft |
| Materials | HDPE; PP, | HDPE; PP, | HDPE; PP, | HDPE; PP, | HDPE; PP, PVC ** | HDPE; PP, PVC ** | HDPE; PP, PVC ** | HDPE; PP, PVC ** |
| Twin wall sheets | √ | √ | √ | √ | √ | √ | √ | √ |
| Welding line | √ | √ | √ | √ | √ | √ | √ | √ |
| Welding 90° (A)* | √ | √ | √ | √ | √ | √ | √ | √ |
| Welding circular (A) ** For details contact RITMO S.P.A. | √ | - | - | - | min Ø 500 mm | min Ø 700 mm | min Ø 500 mm | min Ø 700 mm |
| Sheet locking clamps | mechanical manual | mechanical manual | mechanical manual | hydraulic | hydraulic | hydraulic | hydraulic | hydraulic |
| Locking 90° sheets | mechanical | mechanical | mechanical | mechanical | pneumatic | pneumatic | pneumatic | pneumatic |
| Locking circular sheets | manual | - | - | - | kit | kit | kit | kit |
| Adjusted control panel | √ | √ | √ | √ | - | - | - | - |
| Heating plate lift | mechanical manual | mechanical manual | mechanical manual | mechanical manual | automatic | automatic | automatic | automatic |
| Welding system | manual hydraulic | manual hydraulic | manual hydraulic | manual hydraulic | CNC | CNC | CNC | CNC |
| PRE-SET customized welding cycles | - | - | - | - | √ | √ | √ | √ |
| PDF file | - | - | - | - | √ | √ | √ | √ |
| Memory | - | - | - | - | 4000 reports | 4000 reports | 4000 reports | 4000 reports |
| Display | - | - | - | - | LCD | LCD | LCD | LCD |

(A) On request

** Contact RITMO

*** The welding dimensions refer to PP / HDPE with welding pressure of 0.17 N / mm²



BUTT FUSION MACHINES *LIQUID DRAINAGE*



| WORKING RANGE Ø mm | 40 | 50 | 63 | 75 | 90 | 110 | 125 | 140 | 160 | 180 | 200 | 225 | 250 | 280 | 315 |
|----------------------|----|----|----|----|----|-----|-----|-----|-----|-----|-----|-----|-----|-----|-----|
| MINI 160 JOYT | 40 | 50 | 63 | 75 | 90 | 110 | 125 | 140 | 160 | | | | | | |
| MINI 160 JOYT ELBOWS | 40 | 50 | 63 | 75 | 90 | 110 | 125 | 140 | 160 | | | | | | |
| VR 160 JOYT | 40 | 50 | 63 | 75 | 90 | 110 | 125 | 140 | 160 | | | | | | |
| VR 250 | | | | 75 | 90 | 110 | 125 | 140 | 160 | 180 | 200 | 225 | 250 | | |
| MAXI 315 | | | | | 90 | 110 | 125 | 140 | 160 | 180 | 200 | 225 | 250 | 280 | 315 |
| WORKING RANGE Ø mm | 40 | 50 | 63 | 75 | 90 | 110 | 125 | 140 | 160 | 180 | 200 | 225 | 250 | 280 | 315 |

| WORKING RANGE Ø mm / in | 110 mm / 3" DIPS | 125 mm / 4" DIPS | 180 mm / 6" DIPS | 280 mm / 10" DIPS |
|-------------------------|------------------|------------------|------------------|-------------------|
| TP 125 /45° | • | | | |
| TP 125 | • | • | | |
| TP 200 | • | • | • | |
| TP 300 | • | • | • | • |



TP 125/45°



TP 125



TP 200



TP 300

HEATING PLATES SERIES FOR BUTT WELDING

Series of manual instruments equipped with an aluminum heating plate Teflon-coated (PTFE) and a practical heat-insulated plastic handle. Available in two versions: one with a fixed mechanical thermostat (TF) and one with an adjustable electronic thermoregulator (TE). The heating plates are available in different shapes and working ranges according to the operator's requirements.

STANDARD COMPOSITION

All the models are supplied with:

- A basic heating plate
- A fork support

ON REQUEST

- Bench vice support (the same for all models except TP 300)
- Transportation box in electro-painted steel

TECHNICAL FEATURES

| TYPE: TE, TF | TP 125 | TP 125/45° | TP 200 | TP 300 |
|--|--|--|--|--|
| Working range | up to Ø 125 mm; 4" DIPS | up to Ø 110 mm; 3" DIPS | up to Ø 180 mm; 6" DIPS | up to Ø 280 mm; 10" DIPS |
| Materials TE | HDPE, PP, PVC, PVDF | HDPE, PP, PVC, PVDF | HDPE, PP, PVC, PVDF | HDPE, PP, PVC, PVDF |
| Materials TF | HDPE | HDPE | HDPE | HDPE |
| Power supply | 230 V S. Ph. 50/60 Hz | 230 V S. Ph. 50/60 Hz | 110 V S. Ph. 50/60 Hz (TE) 230 V S. Ph. 50/60 Hz | 230 V S. Ph. 50/60 Hz |
| Max. absorbed power | 700 W | 500 W | 850 W (TE 110 V) 1200 W | 1300 W |
| Working temperature | 180° ÷ 280° C ± 1% TE (356° ÷ 536° F ± 1% TE) 210° C ± 5% TF (410° F ± 5% TF) | 180° ÷ 280° C ± 1% TE (356° ÷ 536° F ± 1% TE) 210° C ± 5% TF (410° F ± 5% TF) | 180° ÷ 280° C ± 1% TE (356° ÷ 536° F ± 1% TE) 210° C ± 5% TF (410° F ± 5% TF) | 180° ÷ 280° C ± 1% TE (356° ÷ 536° F ± 1% TE) 210° C ± 5% TF (410° F ± 5% TF) |
| Ambient temperature | -5° ÷ 40° C | 5° ÷ 40° C | 5° ÷ 40° C | 5° ÷ 40° C |
| Time to reach welding temperature (TE) | ~ 10' | ~ 10' | ~ 10' | ~ 10' |
| Weight | 2,16 Kg (4.7 lb) | 1,95 Kg (4.3 lb) | 3,21 Kg (7 lb) | 5,09 Kg (11.2 lb) |
| Dimensions | 140 x 50 x 410 mm 5.5" x 2" x 16.1" | 140 x 130 x 370 mm 5.5" x 5.1" x 14.6" | 200 x 50 x 440 mm 7.9" x 2" x 17.3" | 300 x 50 x 550 mm 11.8" x 2" x 21.6" |



MINI 160 JOYT - MINI 160 JOYT ELBOWS

MINI 160 JOYT and MINI 160 JOYT ELBOWS are portable butt fusion welders for drainage pipes up to \varnothing 160 mm. These machines are characterized by the extractable heating plate, the safety microswitches on the milling cutter to avoid accidental starting, the articulated lateral supports. The Mini 160 Joyt has a frame, most useful during working and transportation. MINI 160 JOYT ELBOWS features special jaws for manufacturing elbows.

Available in two versions: one with a fixed mechanical thermostat (TF) and one with an adjustable electronic thermoregulator (TE).

- The machine body includes a spring-loaded pressure-regulating device and the rack-feed movement of the carriage provided by a handwheel.
- The rapid-lock clamps, in order to be able to lock elbows (also with a very short neck), tees and Y-branches without the need of any additional device.
- The protection housing around the heating element.

STANDARD COMPOSITION

- Machine body (with milling cutter, lateral supports and keys)
- Heating plate TP 200 TE or TP 200 TF
- Right clamp group \varnothing 160 JOYT
- Left clamp group \varnothing 160 JOYT
- Frame MINI 160 JOYT
- Case with set of clamps and lateral supports' adapters \varnothing 40, 50, 63, 75, 90, 110, 125 mm

ON REQUEST

- Clamps and lateral supports' adapters \varnothing 56, 135, 140 mm
- Milling cutter blade SILENT (for Geberit)

TECHNICAL FEATURES

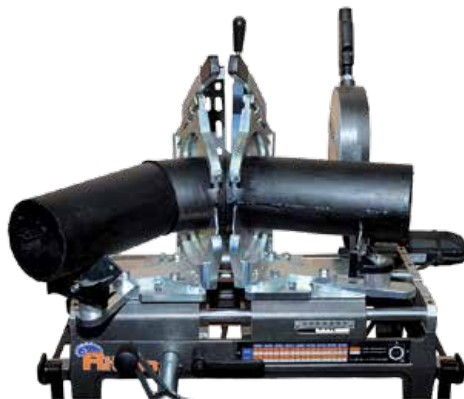

| | |
|-----------------------------------|-----------------------------------|
| Working range | 40 ÷ 160 mm |
| Materials | HDPE, PP, PVDF |
| Power supply | 230 V Single Phase 50/60 Hz |
| Max. absorbed power | 2250 W |
| Working temperature | 180° ÷ 280° C (TE) 210° C (TF) |
| Outside temperature range | -5° ÷ 40° C |
| Time to reach welding temperature | ~ 10' (TE) |
| Weight | 50 Kg |
| Dimensions machine working | 664 x 580 x 1235 mm |



VR 160 JOYT

VR 160 JOYT is portable butt fusion welder for drainage pipes up to \varnothing 160 mm. This machine is characterized by the extractable heating plate, the safety microswitches on the milling cutter to avoid accidental starting, the articulated lateral supports. The VR 160 JOYT has steel box that can be used either as a work bench or as a protection for transportation.

Available in two versions: one with a fixed mechanical thermostat (TF) and one with an adjustable electronic thermoregulator (TE).

- The machine body includes a spring-loaded pressure-regulating device and the rack-feed movement of the carriage provided by a handwheel.
- The rapid-lock clamps, in order to be able to lock elbows (also with a very short neck), tees and Y-branches without the need of any additional device.
- The protection housing around the heating element.

STANDARD COMPOSITION

- Machine body (with milling cutter, lateral supports and keys)
- Heating plate TP 200 TE or TP 200 TF
- Right clamp group \varnothing 160 JOYT
- Left clamp group \varnothing 160 JOYT
- Frame VR 160 JOYT
- Case with set of clamps and lateral supports' adapters \varnothing 40, 50, 63, 75, 90, 110, 125 mm

ON REQUEST

- Clamps and lateral supports' adapters \varnothing 56, 135, 140 mm
- Milling cutter blade SILENT (for Geberit)

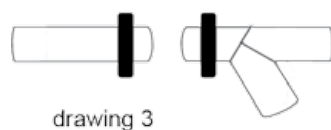
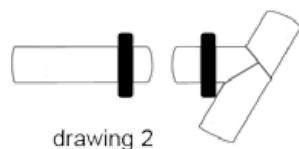

The meaning of JOYT

This word identifies the type of clamps adopted on this machine. They have been specifically designed to be able to lock Y-branches in all the possible positions (drawings 1,2,3).

TECHNICAL FEATURES

| | |
|-----------------------------------|-----------------------------------|
| Working range | 40 ÷ 160 mm |
| Materials | HDPE, PP, PVDF |
| Power supply | 230 V Single Phase 50/60 Hz |
| Max. absorbed power | 2100 W |
| Working temperature | 180° ÷ 280° C (TE) 210° C (TF) |
| Outside temperature range | -5° ÷ 40° C |
| Time to reach welding temperature | ~ 10' (TE) |
| Weight | 95 Kg |
| Dimensions machine working | 1055 x 925 x 1235 mm |



VR 250

A professional welding machine ideal for medium sized pipes and sewers up to \varnothing 250 mm. It consists of a machine body with a pressure regulating device, a pair of clamps, two lateral supports, an electrically controlled milling cutter for levelling the ends of the pipe and/or fitting with a safety microswitch, an extractable heating plate with automatic device to control the temperature, a sliding support and a steel case that acts as a work bench and cover when transporting the machine. The VR 250 can weld fittings such as bends and tees. Branches can also be welded thanks to the upper extractable jaws (on request) called SUPRA.

STANDARD COMPOSITION

- Machine body with a milling cutter, lateral supports, clamps adapters and lateral supports adapters from \varnothing 75 to \varnothing 250 mm (\varnothing 140 and 180 mm on request), working/transport case steel, service spanners
- TP VR 250 TE plate
- Right and left clamp \varnothing 250 mm

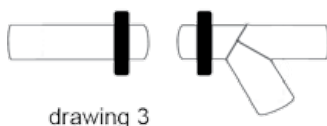
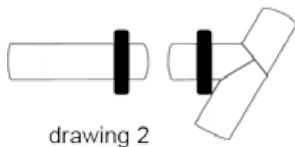
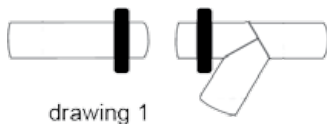

The meaning of SUPRA

This word identifies the different type of clamps mounted on this welding machine. They have been specifically designed to be able to lock "branch" fittings: with extractable and interchangeable jaws, shaped according to the diameter to weld, it is possible to lock all branch points (drawings 1, 2, 3).

ON REQUEST

- Clamps adapters \varnothing 140 and 180 mm
- Lateral supports adapters \varnothing 140 and 180 mm
- Sets of extractable upper jaws SUPRA from \varnothing 75 to 225 mm
- Wooden case for SUPRA extractable upper jaws

TECHNICAL FEATURES

| | |
|-----------------------------------|-----------------------------|
| Working range | 75 ÷ 250 mm |
| Materials | HDPE, PP, PB, PVDF |
| Power supply | 230 V Single Phase 50/60 Hz |
| Max. absorbed power | 2200 W |
| Working temperature | 180° ÷ 280° C |
| Outside temperature range | -5° ÷ 40° C |
| Time to reach welding temperature | ~ 20' |
| Weight | 123 Kg |
| Dimensions machine working | 835 x 1240 x 1530 mm |

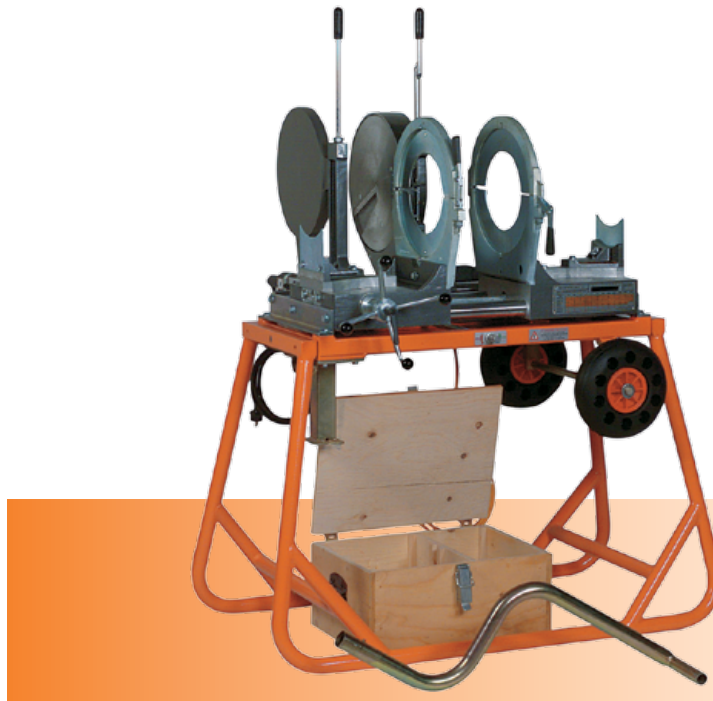

MAXI 315

A professional welding machine ideal for medium sized pipes and sewers up to \varnothing 315 mm. It consists of a machine body with pressure regulating device, a pair of clamps, two lateral supports, an electrically controlled milling cutter for levelling the ends of the pipe and/or fitting with a safety microswitch, an extractable heating plate with automatic electronic device to control the temperature, a sliding support, a tip-up metal frame on wheels that acts as a work bench and protection when transporting the machine. The MAXI 315 can weld fittings such as bends and tees. Branches can also be welded thanks to the single clamps (available on request) indicated for all diameters in the working range.

STANDARD COMPOSITION

- Machine body with a milling cutter and lateral supports
- TP 315 TE plate
- Right and Left clamp \varnothing 315
- Steel frame on wheels (for transporting and for use as a work bench)
- Wooden case with clamps and lateral supports adapters \varnothing 200 and 250 mm

ON REQUEST

- Clamp adapters \varnothing 90, 110, 125, 140, 160, 180, 225, 280 mm
- Lateral supports adapters \varnothing 90, 110, 125, 140, 160, 180, 225, 280 mm

TECHNICAL FEATURES



| | |
|-----------------------------------|-----------------------------|
| Working range | 90 ÷ 315 mm |
| Materials | HDPE, PP, PB, PVDF |
| Power supply | 230 V Single Phase 50/60 Hz |
| Max. absorbed power | 3900 W |
| Working temperature | 180° ÷ 280° C |
| Outside temperature range | -5° ÷ 40° C |
| Time to reach welding temperature | ~ 20' |
| Weight | 183 Kg |
| Dimensions machine working | 1420 x 1300 x 1570 mm |



**Ritmo**
PLASTIC WELDING TECHNOLOGY



The information and photos in this publication are not binding and RITMO S.P.A. is free to make any alterations without prior notice.



RITMO S.p.A.

Via A. Volta, 35/37 - 35037
Bressano di Teolo (PADOVA) ITALY

Ph. +39 049 9901888
Fax +39 049 9901993

info@ritmo.it
www.ritmo.it

